

Type C1H

High Current Rated Fast Acting Chip Fuse

HF  C1H Series – 1206 Size

RoHS Compliant

Features

- Quick Acting
- Small size, 1206 SMD
- Current rating from 10A to 30A
- Wide operating temperature range from -55°C to 125°C
- Tape and Reel for automatic SMD placement
- Compatible with 260°C IR Pb-free and wave soldering process
- Full compliance with EU Directive 2011/65/EU and amending directive 2015/863 (MSL = 1)
- Halogen Free and Lead Free
- AEC-Q Compliant
- Meets Bel automotive qualification*
- * - Largely based on internal AEC-Q test plan

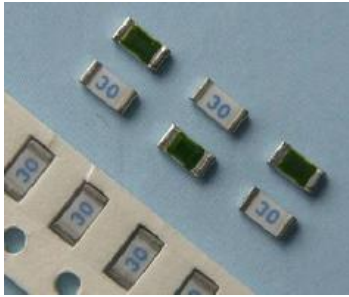

AEC-Q Compliant

Applications

- Notebook
- PC computer
- Office electronic equipment
- Industrial equipment
- Medical equipment
- POE, POE+
- LCD / LED monitor and LCD / LED TV
- Power supply
- DC-DC Converter

LEAD FREE = 
 HALOGEN FREE = 

Typical Part Marking

Fuse body (ceramic white side) marked with marking code.

Example:

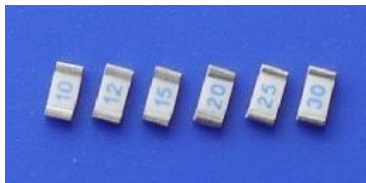

Current Rating	Marking Code	Current Rating	Marking Code
10A	10	20A	20
12A	12	25A	25
15A	15	30A	30

Electrical Characteristics (UL STD. 248-14)



Testing Current	Blow Time	
	Minimum	Maximum
100%	4 Hrs.	N/A
350%	N/A	5 Sec

Safety Agency Approvals

Safety Agency	Safety Agency Certificate	Ampere Rating/ Voltage Rating	Ampere Range / Volt @ I.R. ability*
	E20624	10A - 30A / 32V DC 125V AC	10A - 15A / 32V @150A DC 125V @150A AC
			20A - 30A / 32V @300A DC 125V @150A AC

*I.R.= Interrupting Rating = Short Circuit Rating(Amps)

Physical Specifications

Materials	Body : Ceramic Substrate
	Terminations : Ag / Ni / Sn (100% Lead-free)
	Element Cover Coating : Lead-free Glass
Marking	On Fuse : "Marking Code" in blue color
	On Label : "bel", "C1H", "Current Rating", "Voltage Rating", "Interrupting Rating", "Appropriate Safety Logos" and "  ", "  " (China RoHS compliant).

Specifications subject to change without notice

Temperature Derating Curve

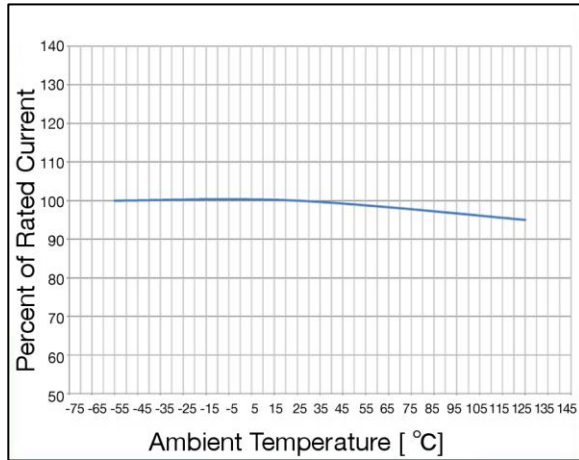

Average Time Current Curve

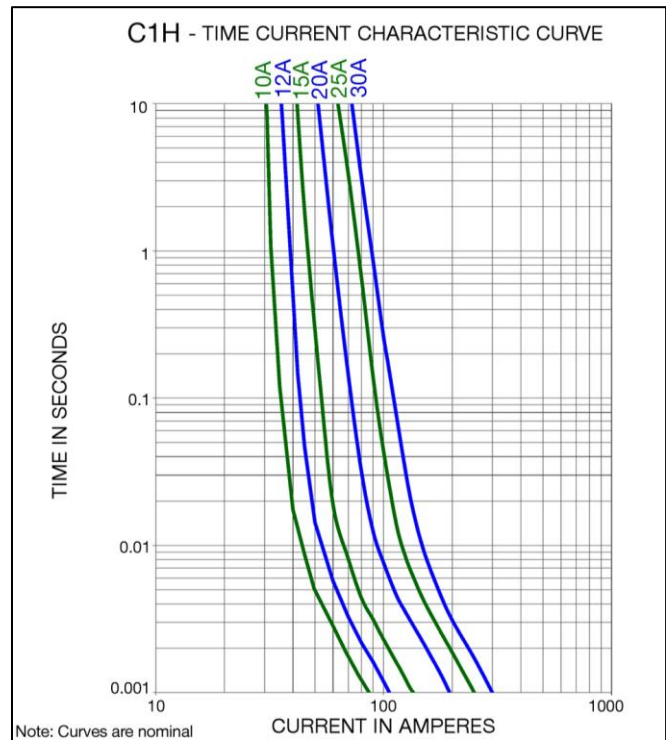

Electrical Specifications

Part Number	Ampere Rating (A)	Marking Code	Nominal Cold Resistance (ohms)	Maximum Volt-drop @ 100% In (Volt) max.	Voltage and Interrupting Ratings	Nominal Melting I ² T @ 10 In (A ² Sec)	Maximum Power Dissipation @ 100% In (W)	Agency Approvals
0685H9100-XX	10A	10	0.0039	0.047	See Table of Safety Approvals on Page 1 for Voltage and associated Interrupting Ratings	5.9	0.47	Y
0685H9120-XX	12A	12	0.0032	0.047		8.0	0.56	Y
0685H9150-XX	15A	15	0.0026	0.050		13.5	0.75	Y
0685H9200-XX	20A	20	0.0019	0.052		28.5	1.04	Y
0685H9250-XX	25A	25	0.0014	0.050		53.4	1.25	Y
0685H9300-XX	30A	30	0.0011	0.053		80.5	1.59	Y

Consult manufacturer for other ratings

NOTES: Test Conditions

All C1H test, as well as the UL Component investigation, were conducted with fuse samples soldered on a PCB (1.6mm thick) test board with copper traces measuring 0.1 mm (100µm) nominal thickness (3 oz.clad), 10mm wide and 100 mm overall length.

Device designed to be mounted with marking facing up.

Device designed to carry rated current for 4 hours minimum. It is recommended that device be operated continuously at no more than 80% of rated current when in a +25°C ambient, with further derating at elevated ambient temperatures.

Caution

Minimum fusing point

C1H Series fuses are NOT intended to be operated at currents between 100% and 350% of ampere rating. Prolonged operation at currents in this range may result in overheating of the fuse and/or desoldering of the fuse from the PCB pad.



Specifications subject to change without notice

Bel Fuse Inc.
206 Van Vorst Street
Jersey City, NJ 07302 USA

+1 201.432.0463
Bel.US.CS@belf.com
belfuse.com/circuit-protection

Environmental Specifications

Shock Resistance	MIL-STD-202G, Method 213B, Test Condition 1 (100 G's peak for 6 milliseconds; Sawtooth waveform)
Vibration Resistance	MIL-STD-202G, Method 201A (10-55 Hz, 0.06 inch, total excursion).
Salt Spray Resistance	MIL-STD-202G, Method 101E, Test Condition B (48 hrs.).
Insulation Resistance	MIL-STD-202G, Method 302, Test Condition A (After Opening) 10,000 ohms minimum.
Solderability	MIL-STD-202G, Method 208H
Resistance to solder Heat	MIL-STD-202G, Method 210F, Test Condition C. Top Side(260°C, 20 sec) MIL-STD-202G, Method 210F, Test Condition D. Bottom Side(260°C, 10 sec)
Thermal Shock	MIL-STD-202G, Method 107G, Test Condition B (-65°C to +125°C).
Operating Temperature	-55°C to +125°C
Moisture Sensitivity Level	1 (According to IPC J-Std-020)

High temperature storage	MIL-STD-202 Method 108
Temperature cycling	JESD22 Method JA-104, Test Condition B
Biased humidity	MIL-STD-202 Method 103, 85C/85% RH with 10% operating power for 1000 hrs.
Operational life	MIL-STD-202 Method 108, Test Condition D
Resistance to solvents	MIL-STD-202 Method 215
Mechanical shock	MIL-STD-202 Method 213, Test Condition C
Vibration	MIL-STD-202 Method 204
Resistance to soldering heat	MIL-STD-202 Method 210, Test condition B
Thermal shock	MIL-STD-202 Method 107
Solderability	J-STD-002
Board flex(SMD)	AEC-Q200-005
Terminal strength	AEC-Q200-006
Electrical characterization	3 temperature electrical

Soldering Parameters

IR Reflow Profile (IPC/JEDEC J-STD-020D)	
Preheat & Soak	
Temperature min (T_{smin})	150°C
Temperature max (T_{smax})	200°C
Time (T_{smin} to T_{smax}) (t_s)	60-120 seconds
Average ramp-up rate (T_{smax} to T_p)	3°C/second max.
Liquidous temperature (T_L)	217°C
Time at liquidous (t_L)	60-150 seconds
Peak temperature (T_p)	260°C max
Time (t_p) within 5°C of the specified classification temperature (T_c)	30 seconds
Average ramp-down rate (T_p to T_{smax})	6°C/second max.
Time 25°C to peak temperature	8 minutes max.

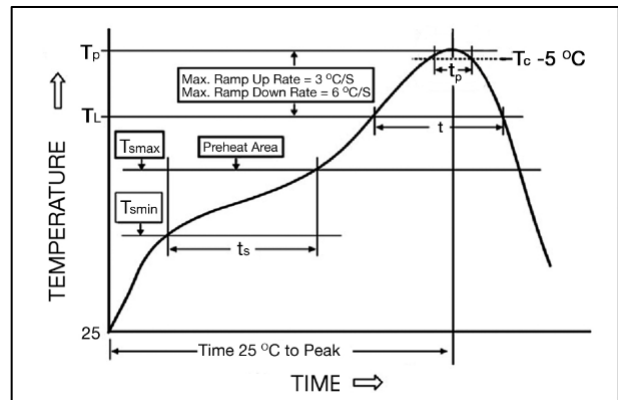

Lead-free Wave Soldering Profile	
Wave Soldering Parameter	
Average ramp-up rate	200°C / second
Heating rate during preheat	typical 1 - 2°C / second Max 4°C / second
Final preheat temperature	within 125°C of soldering temperature
Peak temperature T_p	260°C
Time within +0°C / -5°C of actual peak temperature	10 seconds
Ramp-down rate	5°C / second max.

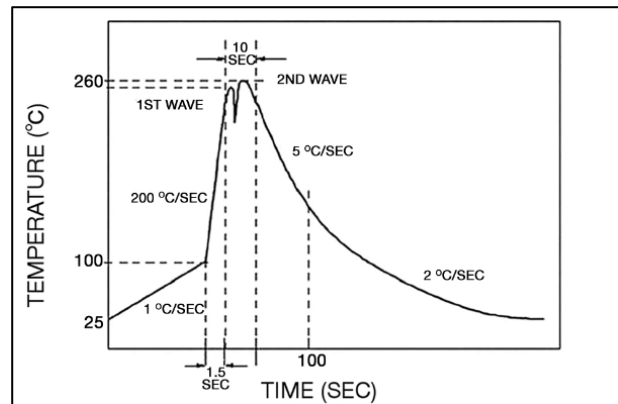

Specifications subject to change without notice



Bel Fuse Inc.
206 Van Vorst Street
Jersey City, NJ 07302 USA

+1 201.432.0463
Bel.US.CS@belf.com
belfuse.com/circuit-protection

Fuse FGNO Explanation

0685 H [XXXX] -XX

0685H=C1H; [XXXX]=Ampere Rating; XX=See Ordering Information as below

Amps	Bel FGNO[XXXX]
10	9100
12	9120
15	9150
20	9200
25	9250
30	9300

Mechanical Dimensions

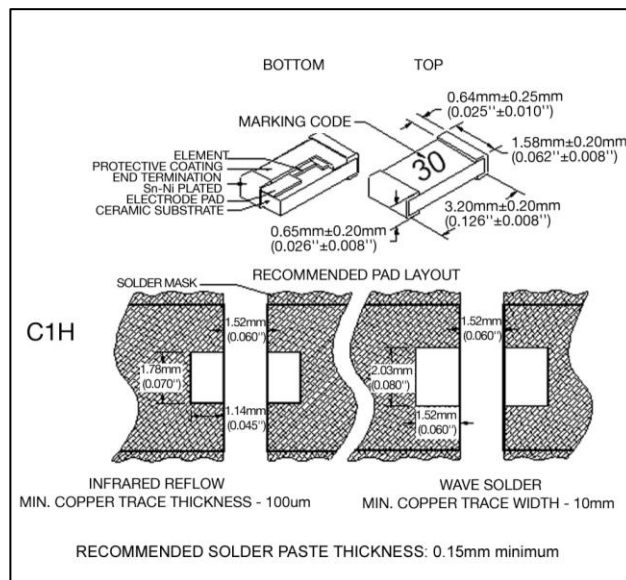

Ordering Information

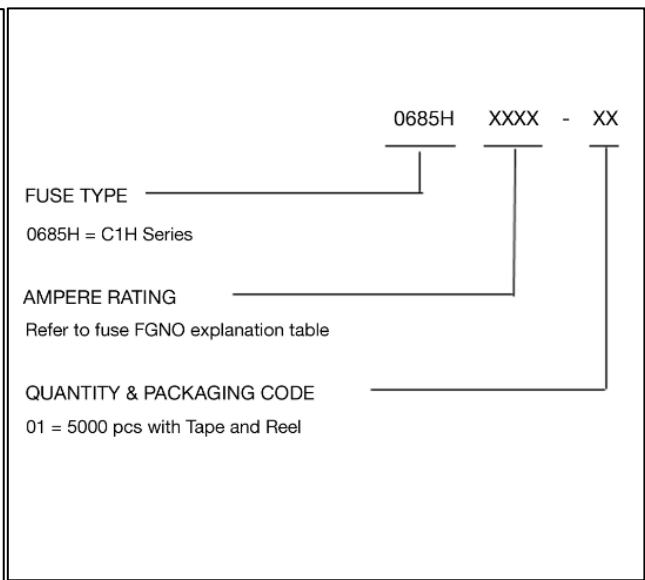

Packaging

Packaging Tape & Reel	Packaging Specification	Quantity	Quantity & Packaging Code
8 mm wide tape with 7 inches Diameter reel	EIA Standard 481-E	5000	0685HXXXX-01