

## Features:

- ◇ PLCC-2 package.
- ◇ White package.
- ◇ Optical indicator.
- ◇ Colorless clear window.
- ◇ Ideal for backlight and light pipe application.
- ◇ Inter reflector.
- ◇ Wide viewing angle.
- ◇ Suitable for automatic placement equipment.
- ◇ Suitable for vapor-phase reflow, Infrared reflow and wave solder processes.
- ◇ Available on tape and reel (8mm Tape).
- ◇ The product itself will remain within RoHS compliant Version.

## Descriptions:

- ◇ This series is available in soft red, orange, yellow, green, blue and white. Due to the package design, the LED has wide viewing angle and optimized light coupling by inter reflector. This feature makes the SMT TOP LED ideal for light pipe application. The low current requirement makes this device ideal for portable equipment or any other application where power is at a premium.
- ◇ The white LED which was fabricated using a blue LED and a phosphor, and the phosphor is excited by blue light and emits yellow fluorescence the mixture of blue light and yellow light results in white emission.
- ◇ Utilizing advanced InGaN chip technology.

## Applications:

- ◇ Automotive: Backlighting in dashboards and switches.
- ◇ Telecommunication: Indicator and backlight in telephone and fax
- ◇ Indicator and backlight for audio and video equipment.
- ◇ Indicator and backlight in office and family equipment.
- ◇ Flat backlight for LCD's, switches and symbols.
- ◇ Light pipe application.
- ◇ General use.

## Package Dimension:

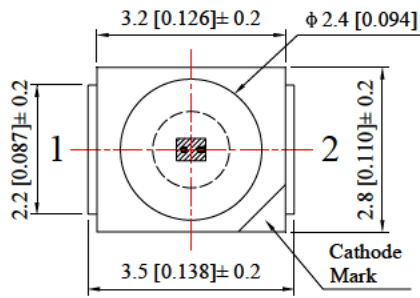

**Polarity**

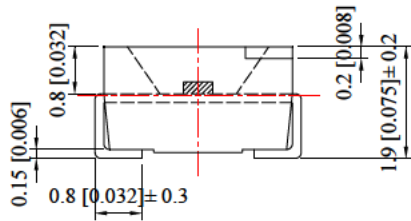

## Recommended Soldering Pad Dimensions

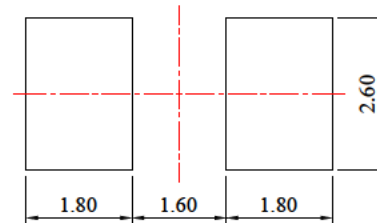
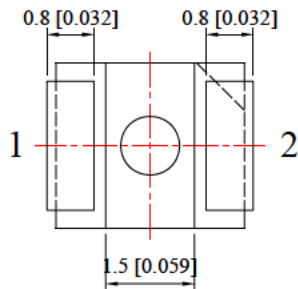

Unit: mm  
Tolerance: ± 0.10mm

Part No.	Chip Material	Lens Color	Source Color
352819-RECD-W-2200	InGaN	Yellow Diffused	Warm White

## Notes:

1. All dimensions are in millimeters.
2. Tolerance is ± 0.10mm (.004") unless otherwise specified.
3. Specifications are subject to change without notice.

## Absolute Maximum Ratings at Ta=25°C

Parameters	Symbol	Max.	Unit
Power Dissipation	PD	95	mW
Peak Forward Current (1/10 Duty Cycle, 0.1ms Pulse Width)	IFP	100	mA
Continuous Forward Current	IF	25	mA
Reverse Voltage	VR	5	V
Electrostatic Discharge (HBM)	ESD	400	V
Operating Temperature Range	Topr	-40°C to +80°C	
Storage Temperature Range	Tstg	-40°C to +85°C	
Soldering Temperature	Tsld	260°C for 5 Seconds	

## Electrical Optical Characteristics at Ta=25°C

Parameters	Symbol	Min.	Typ.	Max.	Unit	Test Condition
Luminous Intensity *	IV	1500	2200	---	mcd	IF=20mA (Note 1)
Luminous Flux *	Φv	5	7	8	lm	
Viewing Angle *	2θ1/2	---	120	---	Deg	IF=20mA (Note 2)
Chromaticity Coordinates	X	---	0.43	---		IF=20mA (Note 3)
	Y	---	0.40	---		
Color Temperature	CCT	2600	3000	3800	K	IF=20mA
Forward Voltage	VF	2.80	3.40	3.80	V	IF=20mA
Reverse Current	IR	---	---	10	μA	VR=5V

### Notes:

- Luminous Intensity (Flux) Measurement allowance is  $\pm 10\%$ .
- $\theta_{1/2}$  is the off-axis angle at which the luminous intensity is half the axial luminous intensity.
- It use many parameters that correspond to the CIE 1931 2°. X, Y, and Z are CIE 1931 2° values of Red, Green and Blue content of the measurement.

## Typical Electrical / Optical Characteristics Curves (25°C Ambient Temperature Unless Otherwise Noted)

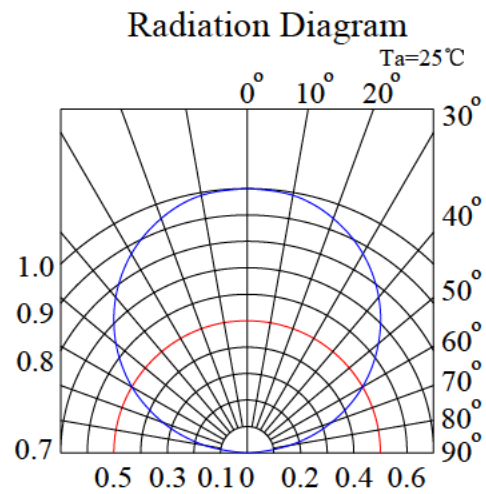
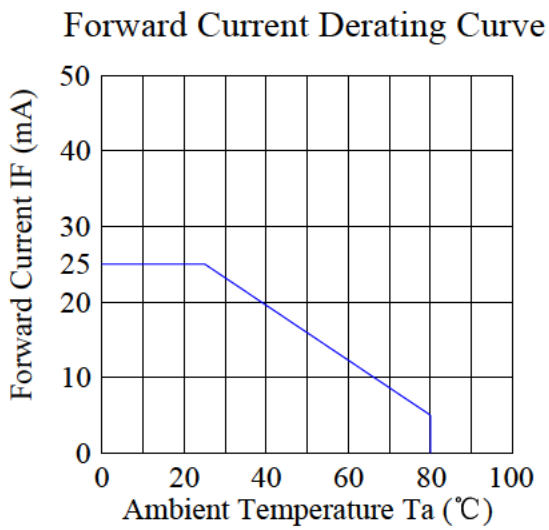
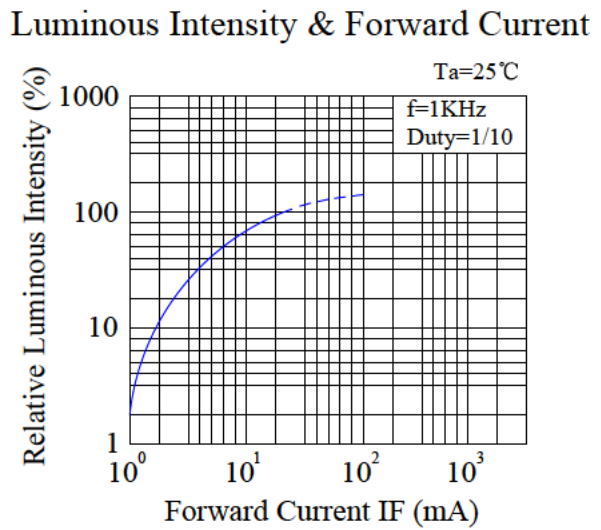
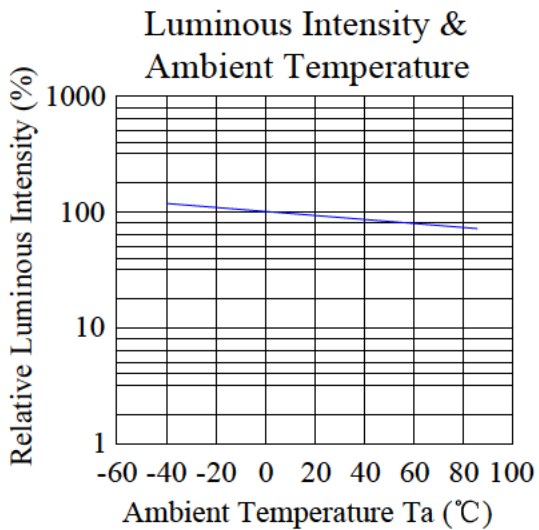
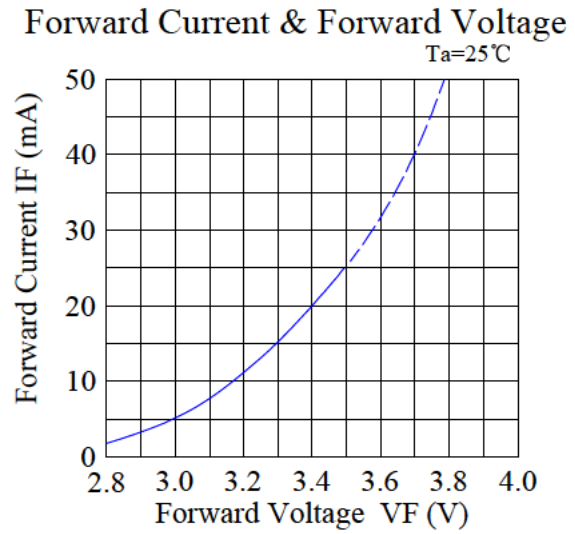
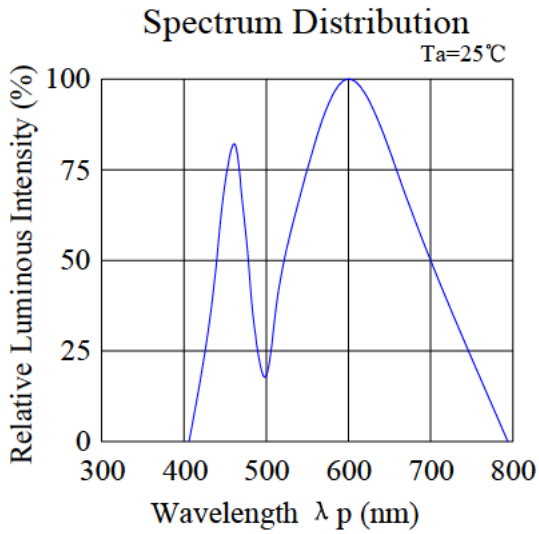

## Warm White CIE 1931 Chromaticity Diagram:

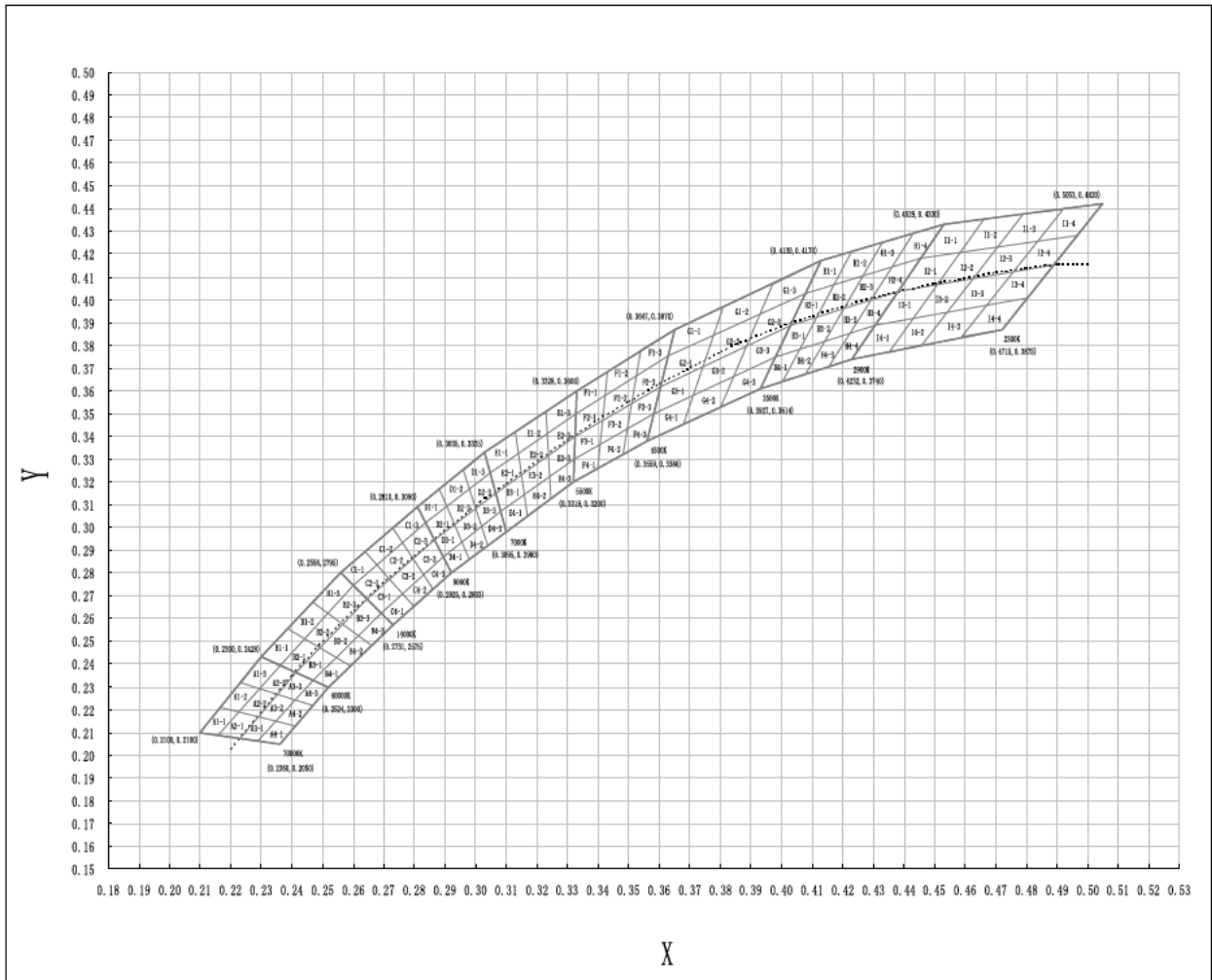

## W6

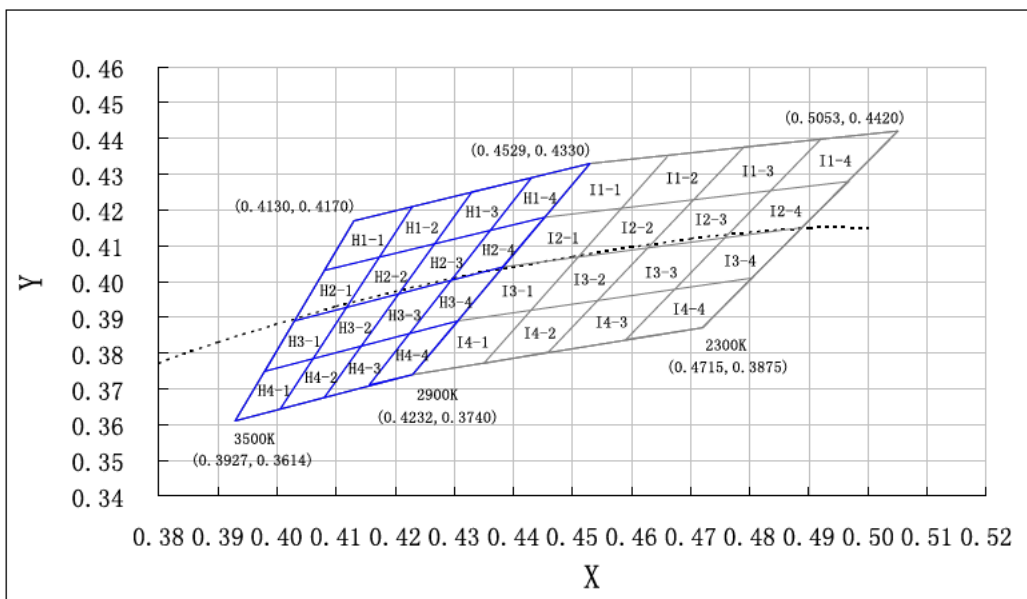

### Chromaticity Coordinates Specifications for Bin Rank:

Bin Code	Left x	Left y	Top x	Top y	Right x	Right y	Bottom x	Bottom y
H1-1	0.4130	0.4170	0.4230	0.4210	0.4170	0.4070	0.4080	0.4030
H2-1	0.4080	0.4030	0.4170	0.4070	0.4120	0.3930	0.4030	0.3890
H3-1	0.4030	0.3890	0.4120	0.3930	0.4060	0.3790	0.3980	0.3750
H4-1	0.3980	0.3750	0.4060	0.3790	0.4000	0.3650	0.3930	0.3610
H1-2	0.4230	0.4210	0.4330	0.4250	0.4270	0.4110	0.4170	0.4070
H2-2	0.4170	0.4070	0.4270	0.4110	0.4200	0.3960	0.4120	0.3930
H3-2	0.4120	0.39300	0.4200	0.3960	0.4140	0.3820	0.4060	0.3790
H4-2	0.4060	0.3790	0.4140	0.3820	0.4080	0.3680	0.4000	0.3650
H1-3	0.4330	0.4250	0.4430	0.4290	0.4360	0.4140	0.4270	0.4110
H2-3	0.4270	0.4110	0.4360	0.4140	0.4290	0.4000	0.4200	0.3960
H3-3	0.4200	0.3960	0.4290	0.4000	0.4220	0.3850	0.4140	0.3820
H4-3	0.4140	0.3820	0.4220	0.3850	0.4160	0.3710	0.4080	0.3680
H1-4	0.4430	0.4290	0.4530	0.4330	0.4450	0.4180	0.4360	0.4140
H2-4	0.4360	0.4140	0.4450	0.4180	0.4380	0.4040	0.4290	0.4000
H3-4	0.4290	0.4000	0.4380	0.4040	0.4310	0.3890	0.4220	0.3850
H4-4	0.4220	0.3850	0.4310	0.3890	0.4230	0.3740	0.4160	0.3710
I1-1	0.4530	0.4330	0.4660	0.4350	0.4580	0.4210	0.4450	0.4180
I2-1	0.4450	0.4180	0.4580	0.4210	0.4510	0.4060	0.4380	0.4040
I3-1	0.4380	0.4040	0.4510	0.4060	0.4430	0.3920	0.4310	0.3890
I4-1	0.4310	0.3890	0.4430	0.3920	0.4350	0.3770	0.4230	0.3740
I1-2	0.4660	0.4350	0.4790	0.4380	0.4710	0.4230	0.4580	0.4210
I2-2	0.4580	0.4210	0.4710	0.4230	0.4630	0.4090	0.4510	0.4060
I3-2	0.4510	0.4060	0.4630	0.4090	0.4550	0.3950	0.4430	0.3920
I4-2	0.4430	0.3920	0.4550	0.3950	0.4470	0.3810	0.4350	0.3770
I1-3	0.4790	0.4380	0.4920	0.4400	0.4840	0.4260	0.4710	0.4230
I2-3	0.4710	0.4230	0.4840	0.4260	0.4760	0.4120	0.4630	0.4090
I3-3	0.4630	0.4090	0.4760	0.4120	0.4680	0.3980	0.4550	0.3950
I4-3	0.4550	0.3950	0.4680	0.3980	0.4590	0.3840	0.4470	0.3810
I1-4	0.4920	0.4400	0.5050	0.4420	0.4970	0.4280	0.4840	0.4260
I2-4	0.4840	0.4260	0.4970	0.4280	0.4880	0.4150	0.4760	0.4120
I3-4	0.4760	0.4120	0.4880	0.4150	0.4800	0.4010	0.4680	0.3980
I4-4	0.4680	0.3980	0.4800	0.4010	0.4720	0.3870	0.4590	0.3840

**Notes:**

1. Color coordinates measurement allowance is  $\pm 0.15$ .
2. One delivery will include up to two consecutive color ranks and three luminous intensity ranks of the products the quantity-ratio of the ranks is decided by Ever-led.



## Reliability Test Items And Conditions:

The reliability of products shall be satisfied with items listed below:

Confidence level: 90%.

LTPD: 10%.

### 1) Test Items and Results:

No.	Test Item	Test Hours/Cycles	Test Conditions	Sample Size	Ac/Re
1	Resistance to Soldering Heat	6 Min	Tsld=260±5°C, Min. 5sec	25pcs	0/1
2	Thermal Shock	300 Cycles	H: +100°C 5min ∫ 10 sec L: -10°C 5min	25pcs	0/1
3	Temperature Cycle	300 Cycles	H: +100°C 15min ∫ 5min L: -40°C 15min	25pcs	0/1
4	High Temperature Storage	1000Hrs.	Temp: 100°C	25pcs	0/1
5	DC Operating Life	1000Hrs.	IF=20mA	25pcs	0/1
6	Low Temperature Storage	1000Hrs.	Temp: -40°C	25pcs	0/1
7	High Temperature/ High Humidity	1000Hrs.	85°C/85%RH	25pcs	0/1

### 2) Criteria for Judging the Damage:

Item	Symbol	Test Conditions	Criteria for Judgment	
			Min	Max
Forward Voltage	VF	IF=20mA	---	F.V.*)×1.1
Reverse Current	IR	VR=5V	---	F.V.*)×2.0
Luminous Intensity	IV	IF=20mA	F.V.*)×0.7	---

\*) F.V.: First Value.

## Reel Dimensions:

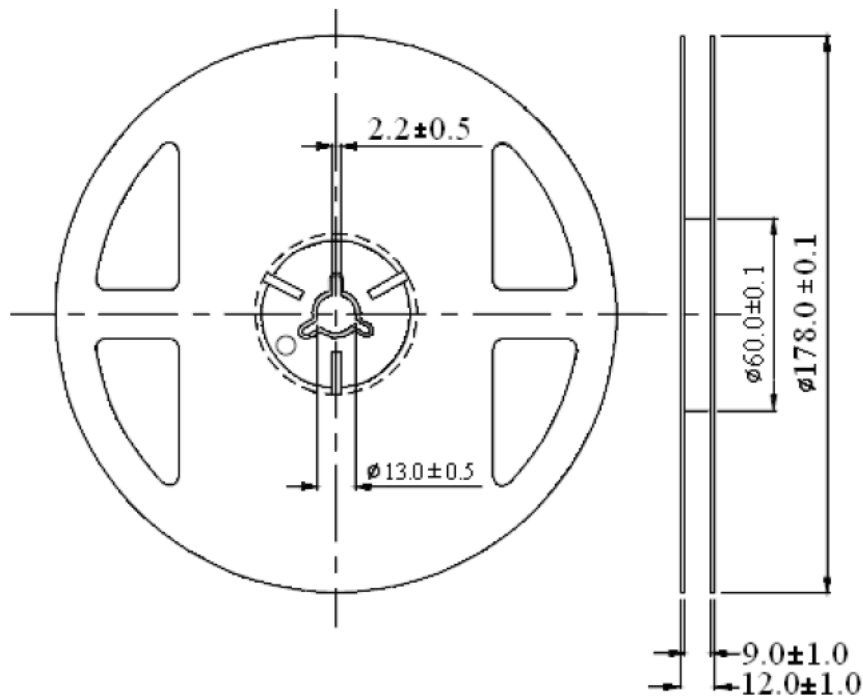

Unit: mm  
Tolerance:  $\pm 0.25$ mm

## Carrier Tape Dimensions:

Loaded quantity 2000PCS per reel.

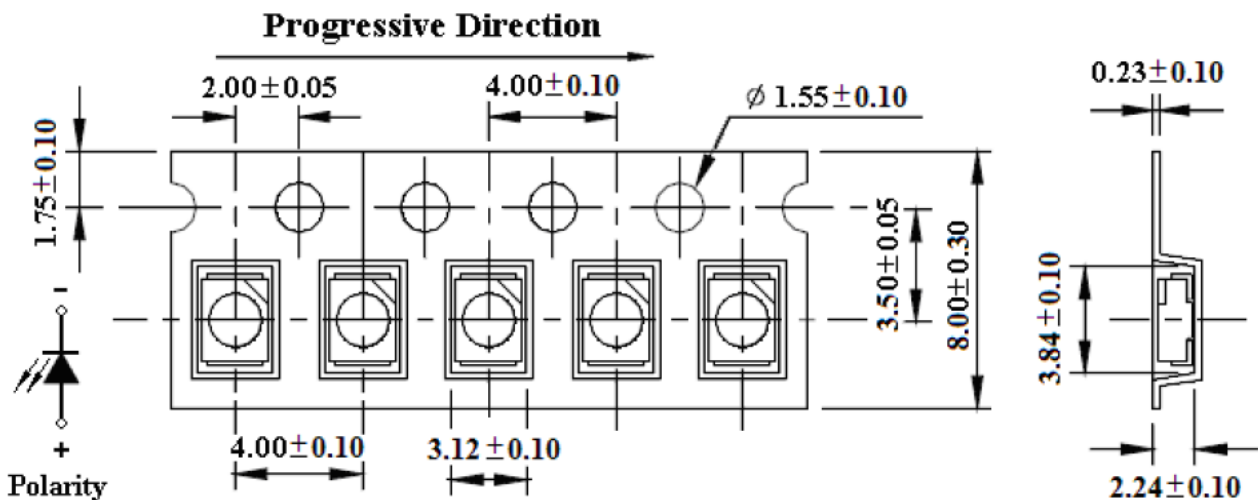

Unit: mm  
Tolerance:  $\pm 0.10$ mm



Please read the following notes before using the product:

## 1. Over-current-proof

Customer must apply resistors for protection, otherwise slight voltage shift will cause big current change (Burn out will happen).

## 2. Storage

2.1 Do not open moisture proof bag before the products are ready to use.

2.2 Before opening the package, the LEDs should be kept at 30°C or less and 80%RH or less.

2.3 The LEDs should be used within a year.

2.4 After opening the package, the LEDs should be kept at 30°C or less and 60%RH or less.

2.5 The LEDs should be used within 168 hours (7 days) after opening the package.

2.6 If the moisture adsorbent material has fabled away or the LEDs have exceeded the storage time, baking treatment should be performed using the following conditions. Baking treatment: 60±5°C for 24 hours.

## 3. Soldering Condition

When soldering, for Lamp without stopper type and must be leave a minimum of 3mm clearance from the base of the lens to the soldering point.

To avoided the Epoxy climb up on lead frame and was impact to non-soldering problem, dipping the lens into the solder must be avoided.

Do not apply any external stress to the lead frame during soldering while the LED is at high temperature.

Recommended soldering conditions:

Soldering Iron		Wave Soldering	
Temperature	300°C Max.	Pre-heat	100°C Max.
Soldering Time	3 sec. Max. (one time only)	Pre-heat Time	60 sec. Max.
		Solder Wave	260°C Max.
		Soldering Time	5 sec. Max.

Note: Excessive soldering temperature and / or time might result in deformation of the LED lens or catastrophic failure of the LED.

## 4. Soldering Iron

Each terminal is to go to the tip of soldering iron temperature less than 260°C for 5 seconds within once in less than the soldering iron capacity 25W. Leave two seconds and more intervals, and do soldering of each terminal. Be careful because the damage of the product is often started at the time of the hand solder.

## 5. Repairing

Repair should not be done after the LEDs have been soldered. When repairing is unavoidable, a double-head soldering iron should be used (as below figure). It should be confirmed beforehand whether the characteristics of the LEDs will or will not be damaged by repairing.

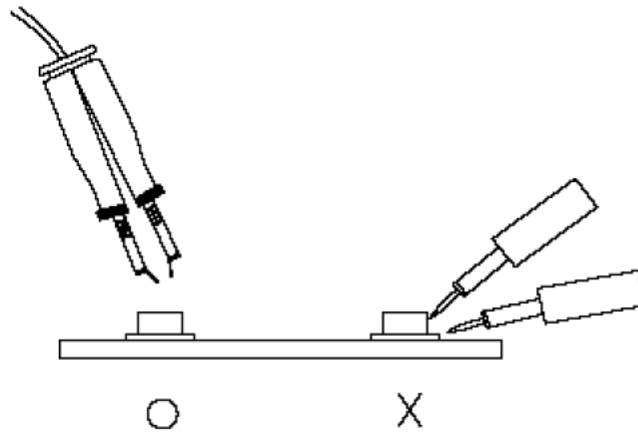

## 6. Caution in ESD

Static Electricity and surge damages the LED. It is recommended to use a wrist band or anti-electrostatic glove when handling the LED. All devices, equipment and machinery must be properly grounded.