

SNx4HC32 Quadruple 2-Input Positive-OR Gates

1 Features

- Wide Operating Voltage Range: 2 V to 6 V
- Outputs Can Drive Up to 10 LSTTL Loads
- Low Power Consumption I_{CC} : 20 μ A (Maximum)
- Typical t_{pd} : 8 ns
- \pm 4-mA Output Drive at 5 V
- Low Input Current: 1 μ A (Maximum)

2 Applications

- Education
- Toys
- Musical Instruments
- Medical Healthcare and Fitness
- Grid Infrastructure
- Electronic Point of Sale
- Test and Measurement
- Factory Automation and Control
- Building Automation

3 Description

The SNx4HC32 devices contain four independent 2-input OR gates. They perform the boolean function $Y = \overline{A} \cdot \overline{B}$ or $Y = A + B$ in positive logic.

Device Information⁽¹⁾

PART NUMBER	PACKAGE	BODY SIZE (NOM)
SN54HC32J	CDIP (14)	19.94 mm x 7.62 mm
SN54HC32W	CFP (14)	9.21 mm x 7.11 mm
SN54HC32FK	LCCC (20)	8.89 mm x 8.89 mm
SN74HC32D	SOIC (14)	4.90 mm x 3.91 mm
SN74HC32DB	SSOP (14)	6.20 mm x 5.30 mm
SN74HC32N	PDIP (14)	19.30 mm x 6.35 mm
SN74HC32NS	SO (14)	10.30 mm x 5.30 mm
SN74HC32PW	TSSOP (14)	5.00 mm x 4.40 mm

(1) For all available packages, see the orderable addendum at the end of the data sheet.

Logic Diagram (Positive Logic)



Copyright © 2016, Texas Instruments Incorporated



An IMPORTANT NOTICE at the end of this data sheet addresses availability, warranty, changes, use in safety-critical applications, intellectual property matters and other important disclaimers. PRODUCTION DATA.

On products compliant to MIL-PRF-38535, all parameters are tested unless otherwise noted. On all other products, production processing does not necessarily include testing of all parameters.

Table of Contents

1 Features	1	8.3 Feature Description	9
2 Applications	1	8.4 Device Functional Modes	9
3 Description	1	9 Application and Implementation	10
4 Revision History	2	9.1 Application Information	10
5 Pin Configuration and Functions	3	9.2 Typical Application	10
6 Specifications	4	10 Power Supply Recommendations	12
6.1 Absolute Maximum Ratings	4	11 Layout	12
6.2 ESD Ratings: SN74HC32	4	11.1 Layout Guidelines	12
6.3 Recommended Operating Conditions	4	11.2 Layout Example	12
6.4 Thermal Information: SN54HC32	5	12 Device and Documentation Support	13
6.5 Thermal Information: SN74HC32	5	12.1 Documentation Support	13
6.6 Electrical Characteristics	5	12.2 Related Links	13
6.7 Switching Characteristics	6	12.3 Receiving Notification of Documentation Updates	13
6.8 Typical Characteristics	7	12.4 Community Resources	13
7 Parameter Measurement Information	8	12.5 Trademarks	13
8 Detailed Description	9	12.6 Electrostatic Discharge Caution	13
8.1 Overview	9	12.7 Glossary	13
8.2 Functional Block Diagram	9	13 Mechanical, Packaging, and Orderable Information	13

4 Revision History

NOTE: Page numbers for previous revisions may differ from page numbers in the current version.

Changes from Revision D (August 2003) to Revision E	Page
• Added <i>ESD Ratings</i> table, <i>Feature Description</i> section, <i>Device Functional Modes</i> , <i>Application and Implementation</i> section, <i>Power Supply Recommendations</i> section, <i>Layout</i> section, <i>Device and Documentation Support</i> section, and <i>Mechanical, Packaging, and Orderable Information</i> section	1
• Removed Ordering Information table	1
• Updated values in the <i>Thermal Information</i> tables to align with JEDEC standards	5

5 Pin Configuration and Functions

D, DB, J, N, NS, PW, W Package
14-Pin SOIC, SSOP, CDIP, PDIP, SOP, TSSOP, CFP
Top View

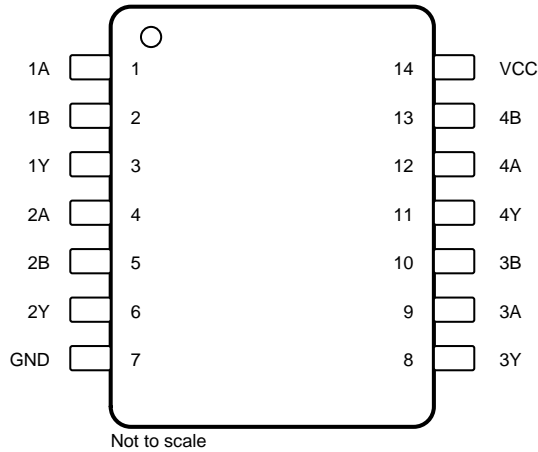

FK Package
20-Pin LCCC
Top View

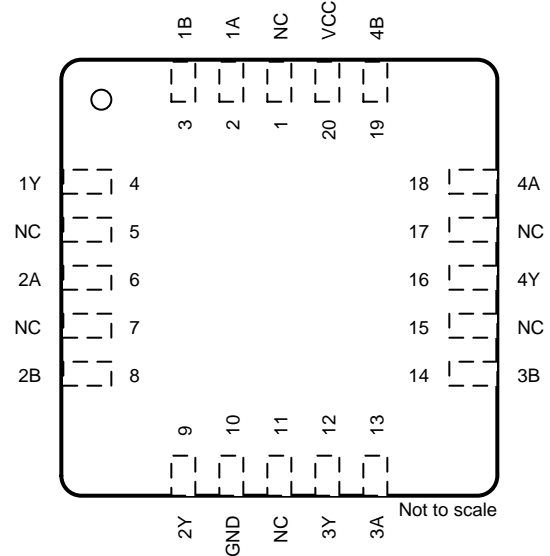

Pin Functions

NAME	PIN		I/O	DESCRIPTION
	D, DB, J, N, NS, PW, W	FK		
1A	1	2	I	Gate 1 input A
1B	2	3	I	Gate 1 input B
1Y	3	4	O	Gate 1 output
2A	4	6	I	Gate 2 input A
2B	5	8	I	Gate 2 input B
2Y	6	9	O	Gate 2 output
3A	9	13	I	Gate 3 input A
3B	10	14	I	Gate 3 input B
3Y	8	12	O	Gate 3 output
4A	12	18	I	Gate 4 input A
4B	13	19	I	Gate 4 input B
4Y	11	16	O	Gate 4 output
GND	7	10	—	Ground
NC	—	1, 5, 7, 11, 15, 17	—	No internal connection
V _{CC}	14	20	—	Power supply

6 Specifications

6.1 Absolute Maximum Ratings

 over operating free-air temperature range (unless otherwise noted)⁽¹⁾

		MIN	MAX	UNIT
V _{CC}	Supply voltage range	–0.5	7	V
I _{IK}	Input clamp current ⁽²⁾	V _I < 0 or V _I > V _{CC}		±20 mA
I _{OK}	Output clamp current ⁽²⁾	V _O < 0 or V _O > V _{CC}		±20 mA
I _O	Continuous output current	V _O = 0 to V _{CC}		±25 mA
	Continuous current through V _{CC} or GND			±50 mA
T _J	Operating virtual junction temperature			150 °C
T _{stg}	Storage temperature range	–65	150	°C

- (1) Stresses beyond those listed under *Absolute Maximum Ratings* may cause permanent damage to the device. These are stress ratings only, and functional operation of the device at these or any other conditions beyond those indicated under *Recommended Operating Conditions* is not implied. Exposure to absolute-maximum-rated conditions for extended periods may affect device reliability.
- (2) The input negative-voltage and output voltage ratings may be exceeded if the input and output current ratings are observed.

6.2 ESD Ratings: SN74HC32

		VALUE	UNIT
V _(ESD)	Electrostatic discharge	Human-body model (HBM), per ANSI/ESDA/JEDEC JS-001 ⁽¹⁾	±2000
		Charged-device model (CDM), per JEDEC specification JESD22-C101 ⁽²⁾	±750

- (1) JEDEC document JEP155 states that 500-V HBM allows safe manufacturing with a standard ESD control process.
- (2) JEDEC document JEP157 states that 250-V CDM allows safe manufacturing with a standard ESD control process.

6.3 Recommended Operating Conditions

 over operating free-air temperature range (unless otherwise noted)⁽¹⁾

		MIN	NOM	MAX	UNIT
V _{CC}	Supply voltage	2	5	6	V
V _{IH}	High-level input voltage	V _{CC} = 2 V	1.5		V
		V _{CC} = 4.5 V	3.15		
		V _{CC} = 6 V	4.2		
V _{IL}	Low-level input voltage	V _{CC} = 2 V		0.5	V
		V _{CC} = 4.5 V		1.35	
		V _{CC} = 6 V		1.8	
V _I	Input voltage	0		V _{CC}	V
V _O	Output voltage	0		V _{CC}	V
Δt/Δv	Input transition rise or fall time	V _{CC} = 2 V		1000	ns
		V _{CC} = 4.5 V		500	
		V _{CC} = 6 V		400	
T _A	Operating free-air temperature	SN54HC32	–55	125	°C
		SN74HC32	–40	85	

- (1) All unused inputs of the device must be held at V_{CC} or GND to ensure proper device operation. Refer to [Implications of Slow or Floating CMOS Inputs](#) application report.

6.4 Thermal Information: SN54HC32

THERMAL METRIC ⁽¹⁾	SN54HC32			UNIT
	CDIP (J)	CFP (W)	LCCC (FK)	
	14 PINS	14 PINS	20 PINS	
$R_{\theta JA}$ Junction-to-ambient thermal resistance	—	—	—	°C/W
$R_{\theta JC(top)}$ Junction-to-case (top) thermal resistance	54.9	88.3	61	°C/W
$R_{\theta JB}$ Junction-to-board thermal resistance	80.1	156	59.6	°C/W
ψ_{JT} Junction-to-top characterization parameter	—	—	—	°C/W
ψ_{JB} Junction-to-board characterization parameter	—	—	—	°C/W
$R_{\theta JC(bot)}$ Junction-to-case (bottom) thermal resistance	25.1	15.2	11.7	°C/W

(1) For more information about traditional and new thermal metrics, see the [Semiconductor and IC Package Thermal Metrics](#) application report.

6.5 Thermal Information: SN74HC32

THERMAL METRIC ⁽¹⁾	SN74HC32					UNIT
	SOIC (D)	SSOP (DB)	PDIP (N)	SOP (NS)	TSSOP (PW)	
	14 PINS	14 PINS	14 PINS	14 PINS	14 PINS	
$R_{\theta JA}$ Junction-to-ambient thermal resistance	90.1	105.4	54.9	88.8	119.6	°C/W
$R_{\theta JC(top)}$ Junction-to-case (top) thermal resistance	50.3	57.3	42.5	46.5	48.4	°C/W
$R_{\theta JB}$ Junction-to-board thermal resistance	44.4	52.7	34.7	47.6	61.3	°C/W
ψ_{JT} Junction-to-top characterization parameter	17.9	22.6	27.9	16.8	5.6	°C/W
ψ_{JB} Junction-to-board characterization parameter	44.1	52.2	34.6	47.2	60.7	°C/W
$R_{\theta JC(bot)}$ Junction-to-case (bottom) thermal resistance	—	—	—	—	—	°C/W

(1) For more information about traditional and new thermal metrics, see the [Semiconductor and IC Package Thermal Metrics](#) application report.

6.6 Electrical Characteristics

over operating free-air temperature range (unless otherwise noted)

PARAMETER	TEST CONDITIONS		MIN	TYP	MAX	UNIT
V_{OH}	$V_I = V_{IH}$ or V_{IL}	$I_{OH} = -20 \mu A$	$V_{CC} = 2 V$	1.9	1.998	V
			$V_{CC} = 4.5 V$	4.4	4.499	
			$V_{CC} = 6 V$	5.9	5.999	
	$I_{OH} = -4 mA, V_{CC} = 4.5 V$	$T_A = 25^\circ C$	3.98	4.3		
		SN54HC32	3.7			
		SN74HC32	3.84			
		$T_A = 25^\circ C$	5.48	5.8		
		SN54HC32	5.2			
$I_{OH} = -5.2 mA, V_{CC} = 6 V$	SN54HC32	5.2				
	SN74HC32	5.34				

Electrical Characteristics (continued)

over operating free-air temperature range (unless otherwise noted)

PARAMETER	TEST CONDITIONS		MIN	TYP	MAX	UNIT
V_{OL}	$V_I = V_{IH}$ or V_{IL}	$I_{OL} = 20 \mu A$	$V_{CC} = 2 V$	0.002	0.1	V
			$V_{CC} = 4.5 V$	0.001	0.1	
			$V_{CC} = 6 V$	0.001	0.1	
	$I_{OL} = 4 mA, V_{CC} = 4.5 V$	$T_A = 25^\circ C$	0.17	0.26		
		SN54HC32		0.4		
		SN74HC32		0.33		
	$I_{OL} = 5.2 mA, V_{CC} = 6 V$	$T_A = 25^\circ C$	0.15	0.26		
		SN54HC32		0.4		
		SN74HC32		0.33		
I_I	$V_I = V_{CC}$ or 0, $V_{CC} = 6 V$	$T_A = 25^\circ C$	± 0.1	± 100	nA	
		SNx4HC32		± 1000		
I_{CC}	$V_I = V_{CC}$ or 0, $I_O = 0, V_{CC} = 6 V$	$T_A = 25^\circ C$		2	μA	
		SN54HC32		40		
		SN74HC32		20		
C_i	$V_{CC} = 2 V$ to $6 V$		3	10	pF	
C_{pd}	Power dissipation capacitance per gate	$T_A = 25^\circ C$, no load		20	pF	

6.7 Switching Characteristics

over operating free-air temperature range (unless otherwise noted; see Figure 4)

PARAMETER	TEST CONDITIONS		MIN	TYP	MAX	UNIT
t_{pd}	$C_L = 50 pF$, from A or B (input) to Y (output)	$V_{CC} = 2 V$	$T_A = 25^\circ C$	50	100	ns
			SN54HC32		150	
			SN74HC32		125	
		$V_{CC} = 4.5 V$	$T_A = 25^\circ C$	10	20	
			SN54HC32		30	
			SN74HC32		25	
		$V_{CC} = 6 V$	$T_A = 25^\circ C$	8	17	
			SN54HC32		25	
			SN74HC32		21	
t_t	$C_L = 50 pF$, to Y (output)	$V_{CC} = 2 V$	$T_A = 25^\circ C$	38	75	ns
			SN54HC32		110	
			SN74HC32		95	
		$V_{CC} = 4.5 V$	$T_A = 25^\circ C$	8	15	
			SN54HC32		22	
			SN74HC32		19	
		$V_{CC} = 6 V$	$T_A = 25^\circ C$	6	13	
			SN54HC32		19	
			SN74HC32		16	

6.8 Typical Characteristics

$T_A = 25^\circ\text{C}$ and $C_L = 50\text{ pF}$

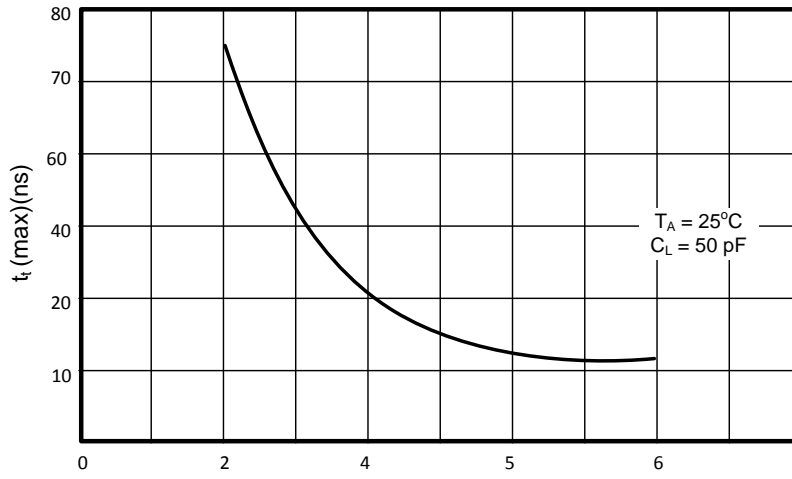

Figure 1. t_t vs V_{CC}

7 Parameter Measurement Information

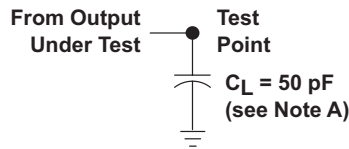

Figure 2. Load Current

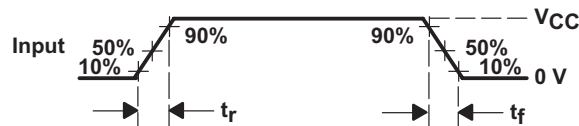
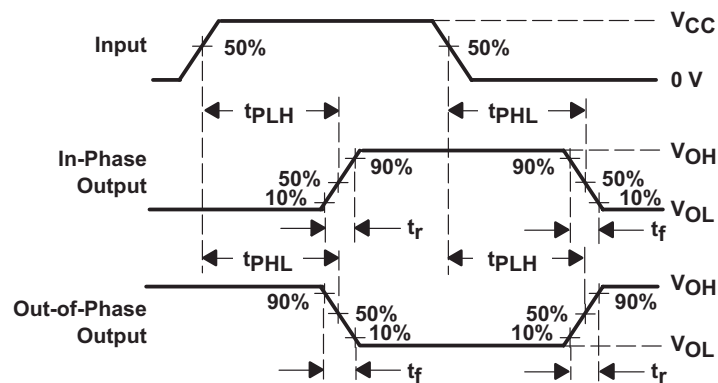

Figure 3. Input Rise and Fall Times



- NOTES:
- C_L includes probe and test-fixture capacitance.
 - Phase relationship between waveforms were chosen arbitrarily. All input pulses are supplied by generators having the following characteristics:
 $PRR \leq 1 \text{ MHz}$, $Z_O = 50 \Omega$, $t_r = 6 \text{ ns}$, $t_f = 6 \text{ ns}$.
 - The outputs are measured one at a time with one input transition per measurements.
 - t_{PLH} and t_{PHL} are the same as t_{pd} .

Figure 4. Propagation Delay and Output Transition Times

8 Detailed Description

8.1 Overview

The SNx4HC32 devices are quad 2-input OR gates. These devices are members of the High-Speed CMOS (HC) logic family. The HC family of logic is optimized to operate with a 5-V supply, is low noise without characteristic overshoot and undershoot, has low power consumption, small propagation delay, balanced propagation delay and transition times, and operates over a wide temperature range.

8.2 Functional Block Diagram

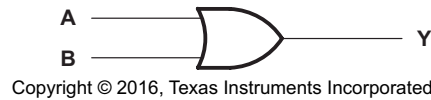

Figure 5. Logic Diagram (Positive Logic)

8.3 Feature Description

8.3.1 Operating Voltage Range

The SNx4HC series of devices offer a wide operating voltage range from 2 V to 6 V.

8.3.2 LSTTL Loads

The outputs of the SNx4HC series can drive up to 10 LSTTL loads.

8.3.3 Low Power Consumption

The SNx4HC32 offers low power consumption of 20 μ A (maximum).

8.3.4 Output Drive Capability

At 5 V, the outputs have ± 4 mA of output drive capability.

8.3.5 Low Input Current Leakage

Inputs have low input current leakage of 1 μ A (maximum).

8.4 Device Functional Modes

[Table 1](#) lists the functional modes of SNx4HC32.

**Table 1. Function Table
(Each Gate)**

INPUTS		OUTPUT
A	B	Y
H	X	H
X	H	H
L	L	L

9 Application and Implementation

NOTE

Information in the following applications sections is not part of the TI component specification, and TI does not warrant its accuracy or completeness. TI's customers are responsible for determining suitability of components for their purposes. Customers should validate and test their design implementation to confirm system functionality.

9.1 Application Information

The SNx4HC32 is an extremely versatile device with far more available applications than could be listed here. The application chosen as an example is using all four OR gates in a single package to provide a four channel output enable from a single active low enable signal (Enable). This circuit outputs a logic HIGH on all channels when disabled (Enable is HIGH), and passes the input signals when enabled (Enable is LOW).

9.2 Typical Application

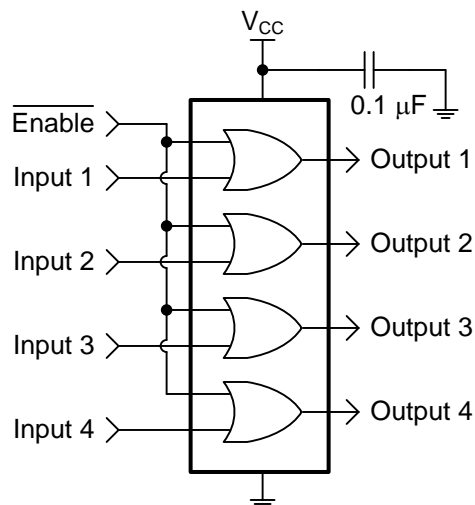

Copyright © 2016, Texas Instruments Incorporated

Using a quad OR gate as a 4-channel active low enable with high output off state.

Figure 6. Typical Application Schematic

9.2.1 Design Requirements

This device uses CMOS technology and has balanced output drive. Take care to avoid bus contention because it can drive currents that would exceed maximum limits. The high drive also creates fast edges into light loads, so routing and load conditions must be considered to prevent ringing.

The minimum output pulse time is approximately three times t_{pd} from [Switching Characteristics](#) for the selected V_{CC} , device, and temperature range.

9.2.2 Detailed Design Procedure

Logic

- All four input channels are to be enabled or disabled simultaneously
- The enable signal is active low (LOW = enabled, HIGH = disabled)
- All four outputs are to output logic HIGH while disabled

Inputs

- Each input must follow requirements specified in [Absolute Maximum Ratings](#):
 - Avoid exceeding input voltages

Typical Application (continued)

- If input voltages ratings must be exceeded, ensure that the maximum input current ratings are not exceeded.
- Ensure that the input signals have edge rates that are equal to or faster than that listed in [Recommended Operating Conditions](#). Slower signals can cause incorrect behavior and possibly damage to the part.
- Each output must also follow requirements in [Absolute Maximum Ratings](#):
 - Avoid bus contention by only connecting outputs together when inputs are tied together directly.
 - Avoid forcing output voltages outside those specified in [Absolute Maximum Ratings](#).
 - If output voltage ratings must be exceeded, ensure that the maximum output current ratings are not exceeded.
 - Ensure that the total current output does not exceed the continuous current through V_{CC} or GND listed in [Absolute Maximum Ratings](#).

9.2.3 Application Curves

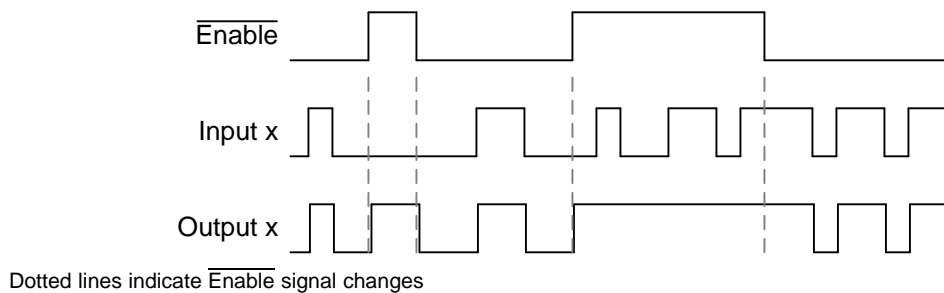

Figure 7. Application Timing Diagram

10 Power Supply Recommendations

The power supply can be any voltage between the minimum and maximum supply voltage rating located in [Recommended Operating Conditions](#). Each V_{CC} pin must have a good bypass capacitor to prevent power disturbance. For devices with a single supply, TI recommends a 0.1- μF bypass capacitor. If there are multiple V_{CC} pins, TI recommends a 0.01- μF or 0.022- μF bypass capacitors for each power pin. It is acceptable to parallel multiple bypass capacitors to reject different frequencies of noise. Two bypass capacitors of value 0.1- μF and 1- μF are commonly used in parallel. For best results, install the bypass capacitor(s) as close to the power pin as possible.

11 Layout

11.1 Layout Guidelines

When using multiple bit logic devices, inputs must not float. In many cases, functions or parts of functions of digital logic devices are unused. Some examples are when only two inputs of a triple-input AND gate are used, or when only 3 of the 4-buffer gates are used. Such input pins must not be left unconnected because the undefined voltages at the outside connections result in undefined operational states. Specified in [Absolute Maximum Ratings](#) are rules that must be observed under all circumstances. All unused inputs of digital logic devices must be connected to a high or low bias to prevent them from floating. The logic level that must be applied to any particular unused input depends on the function of the device. Generally they are tied to GND or V_{CC} , whichever makes more sense or is more convenient. It is acceptable to float outputs unless the part is a transceiver. If the transceiver has an output enable pin, it disables the outputs section of the part when asserted. This does not disable the input section of the I/Os so they also cannot float when disabled.

11.2 Layout Example

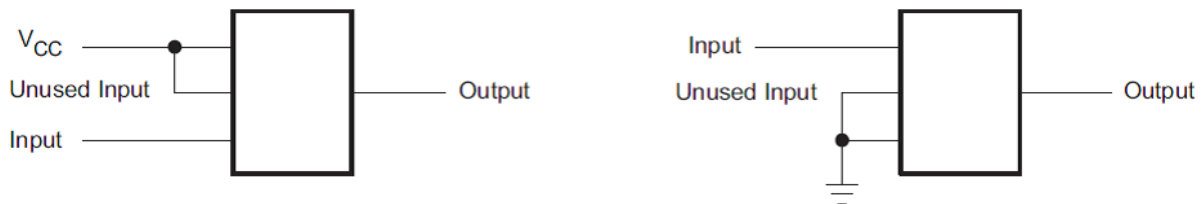

Figure 8. Layout Recommendation

12 Device and Documentation Support

12.1 Documentation Support

12.1.1 Related Documentation

For related documentation see the following:

- [Implications of Slow or Floating CMOS Inputs](#) (SCBA004)

12.2 Related Links

The table below lists quick access links. Categories include technical documents, support and community resources, tools and software, and quick access to sample or buy.

Table 2. Related Links

PARTS	PRODUCT FOLDER	SAMPLE & BUY	TECHNICAL DOCUMENTS	TOOLS & SOFTWARE	SUPPORT & COMMUNITY
SN54HC32	Click here	Click here	Click here	Click here	Click here
SN74HC32	Click here	Click here	Click here	Click here	Click here

12.3 Receiving Notification of Documentation Updates

To receive notification of documentation updates, navigate to the device product folder on ti.com. In the upper right corner, click on *Alert me* to register and receive a weekly digest of any product information that has changed. For change details, review the revision history included in any revised document.

12.4 Community Resources

The following links connect to TI community resources. Linked contents are provided "AS IS" by the respective contributors. They do not constitute TI specifications and do not necessarily reflect TI's views; see TI's [Terms of Use](#).

TI E2E™ Online Community *TI's Engineer-to-Engineer (E2E) Community*. Created to foster collaboration among engineers. At e2e.ti.com, you can ask questions, share knowledge, explore ideas and help solve problems with fellow engineers.

Design Support *TI's Design Support* Quickly find helpful E2E forums along with design support tools and contact information for technical support.

12.5 Trademarks

E2E is a trademark of Texas Instruments.
 All other trademarks are the property of their respective owners.

12.6 Electrostatic Discharge Caution



These devices have limited built-in ESD protection. The leads should be shorted together or the device placed in conductive foam during storage or handling to prevent electrostatic damage to the MOS gates.

12.7 Glossary

[SLYZ022](#) — *TI Glossary*.

This glossary lists and explains terms, acronyms, and definitions.

13 Mechanical, Packaging, and Orderable Information

The following pages include mechanical, packaging, and orderable information. This information is the most current data available for the designated devices. This data is subject to change without notice and revision of this document. For browser-based versions of this data sheet, refer to the left-hand navigation.

PACKAGING INFORMATION

Orderable Device	Status (1)	Package Type	Package Drawing	Pins	Package Qty	Eco Plan (2)	Lead finish/ Ball material (6)	MSL Peak Temp (3)	Op Temp (°C)	Device Marking (4/5)	Samples
5962-8404501VCA	ACTIVE	CDIP	J	14	1	TBD	SNPB	N / A for Pkg Type	-55 to 125	5962-8404501VC A SNV54HC32J	Samples
5962-8404501VDA	ACTIVE	CFP	W	14	1	TBD	SNPB	N / A for Pkg Type	-55 to 125	5962-8404501VD A SNV54HC32W	Samples
84045012A	ACTIVE	LCCC	FK	20	1	TBD	POST-PLATE	N / A for Pkg Type	-55 to 125	84045012A SNJ54HC 32FK	Samples
8404501CA	ACTIVE	CDIP	J	14	1	TBD	SNPB	N / A for Pkg Type	-55 to 125	8404501CA SNJ54HC32J	Samples
8404501DA	ACTIVE	CFP	W	14	1	TBD	SNPB	N / A for Pkg Type	-55 to 125	8404501DA SNJ54HC32W	Samples
JM38510/65201B2A	ACTIVE	LCCC	FK	20	1	TBD	POST-PLATE	N / A for Pkg Type	-55 to 125	JM38510/ 65201B2A	Samples
JM38510/65201BCA	ACTIVE	CDIP	J	14	1	TBD	SNPB	N / A for Pkg Type	-55 to 125	JM38510/ 65201BCA	Samples
JM38510/65201BDA	ACTIVE	CFP	W	14	1	TBD	SNPB	N / A for Pkg Type	-55 to 125	JM38510/ 65201BDA	Samples
M38510/65201B2A	ACTIVE	LCCC	FK	20	1	TBD	POST-PLATE	N / A for Pkg Type	-55 to 125	JM38510/ 65201B2A	Samples
M38510/65201BCA	ACTIVE	CDIP	J	14	1	TBD	SNPB	N / A for Pkg Type	-55 to 125	JM38510/ 65201BCA	Samples
M38510/65201BDA	ACTIVE	CFP	W	14	1	TBD	SNPB	N / A for Pkg Type	-55 to 125	JM38510/ 65201BDA	Samples
SN54HC32J	ACTIVE	CDIP	J	14	1	TBD	SNPB	N / A for Pkg Type	-55 to 125	SN54HC32J	Samples
SN74HC32D	ACTIVE	SOIC	D	14	50	Green (RoHS & no Sb/Br)	NIPDAU	Level-1-260C-UNLIM	-40 to 85	HC32	Samples
SN74HC32DBR	ACTIVE	SSOP	DB	14	2000	Green (RoHS & no Sb/Br)	NIPDAU	Level-1-260C-UNLIM	-40 to 85	HC32	Samples
SN74HC32DE4	ACTIVE	SOIC	D	14	50	Green (RoHS & no Sb/Br)	NIPDAU	Level-1-260C-UNLIM	-40 to 85	HC32	Samples

Orderable Device	Status (1)	Package Type	Package Drawing	Pins	Package Qty	Eco Plan (2)	Lead finish/ Ball material (6)	MSL Peak Temp (3)	Op Temp (°C)	Device Marking (4/5)	Samples
SN74HC32DR	ACTIVE	SOIC	D	14	2500	Green (RoHS & no Sb/Br)	NIPDAU SN	Level-1-260C-UNLIM	-40 to 85	HC32	Samples
SN74HC32DRE4	ACTIVE	SOIC	D	14	2500	Green (RoHS & no Sb/Br)	NIPDAU	Level-1-260C-UNLIM	-40 to 85	HC32	Samples
SN74HC32DRG4	ACTIVE	SOIC	D	14	2500	Green (RoHS & no Sb/Br)	NIPDAU	Level-1-260C-UNLIM	-40 to 85	HC32	Samples
SN74HC32DT	ACTIVE	SOIC	D	14	250	Green (RoHS & no Sb/Br)	NIPDAU	Level-1-260C-UNLIM	-40 to 85	HC32	Samples
SN74HC32N	ACTIVE	PDIP	N	14	25	Green (RoHS & no Sb/Br)	NIPDAU	N / A for Pkg Type	-40 to 85	SN74HC32N	Samples
SN74HC32NE4	ACTIVE	PDIP	N	14	25	Green (RoHS & no Sb/Br)	NIPDAU	N / A for Pkg Type	-40 to 85	SN74HC32N	Samples
SN74HC32NSR	ACTIVE	SO	NS	14	2000	Green (RoHS & no Sb/Br)	NIPDAU	Level-1-260C-UNLIM	-40 to 85	HC32	Samples
SN74HC32PW	ACTIVE	TSSOP	PW	14	90	Green (RoHS & no Sb/Br)	NIPDAU	Level-1-260C-UNLIM	-40 to 85	HC32	Samples
SN74HC32PWG4	ACTIVE	TSSOP	PW	14	90	Green (RoHS & no Sb/Br)	NIPDAU	Level-1-260C-UNLIM	-40 to 85	HC32	Samples
SN74HC32PWR	ACTIVE	TSSOP	PW	14	2000	Green (RoHS & no Sb/Br)	NIPDAU SN	Level-1-260C-UNLIM	-40 to 85	HC32	Samples
SN74HC32PWRG4	ACTIVE	TSSOP	PW	14	2000	Green (RoHS & no Sb/Br)	NIPDAU	Level-1-260C-UNLIM	-40 to 85	HC32	Samples
SN74HC32PWT	ACTIVE	TSSOP	PW	14	250	Green (RoHS & no Sb/Br)	NIPDAU	Level-1-260C-UNLIM	-40 to 85	HC32	Samples
SN74HC32PWTG4	ACTIVE	TSSOP	PW	14	250	Green (RoHS & no Sb/Br)	NIPDAU	Level-1-260C-UNLIM	-40 to 85	HC32	Samples
SNJ54HC32FK	ACTIVE	LCCC	FK	20	1	TBD	POST-PLATE	N / A for Pkg Type	-55 to 125	84045012A SNJ54HC 32FK	Samples
SNJ54HC32J	ACTIVE	CDIP	J	14	1	TBD	SNPB	N / A for Pkg Type	-55 to 125	8404501CA SNJ54HC32J	Samples
SNJ54HC32W	ACTIVE	CFP	W	14	1	TBD	SNPB	N / A for Pkg Type	-55 to 125	8404501DA SNJ54HC32W	Samples

(1) The marketing status values are defined as follows:
ACTIVE: Product device recommended for new designs.

LIFEBUY: TI has announced that the device will be discontinued, and a lifetime-buy period is in effect.

NRND: Not recommended for new designs. Device is in production to support existing customers, but TI does not recommend using this part in a new design.

PREVIEW: Device has been announced but is not in production. Samples may or may not be available.

OBSOLETE: TI has discontinued the production of the device.

⁽²⁾ **RoHS:** TI defines "RoHS" to mean semiconductor products that are compliant with the current EU RoHS requirements for all 10 RoHS substances, including the requirement that RoHS substance do not exceed 0.1% by weight in homogeneous materials. Where designed to be soldered at high temperatures, "RoHS" products are suitable for use in specified lead-free processes. TI may reference these types of products as "Pb-Free".

RoHS Exempt: TI defines "RoHS Exempt" to mean products that contain lead but are compliant with EU RoHS pursuant to a specific EU RoHS exemption.

Green: TI defines "Green" to mean the content of Chlorine (Cl) and Bromine (Br) based flame retardants meet JS709B low halogen requirements of ≤ 1000 ppm threshold. Antimony trioxide based flame retardants must also meet the ≤ 1000 ppm threshold requirement.

⁽³⁾ MSL, Peak Temp. - The Moisture Sensitivity Level rating according to the JEDEC industry standard classifications, and peak solder temperature.

⁽⁴⁾ There may be additional marking, which relates to the logo, the lot trace code information, or the environmental category on the device.

⁽⁵⁾ Multiple Device Markings will be inside parentheses. Only one Device Marking contained in parentheses and separated by a "~" will appear on a device. If a line is indented then it is a continuation of the previous line and the two combined represent the entire Device Marking for that device.

⁽⁶⁾ Lead finish/Ball material - Orderable Devices may have multiple material finish options. Finish options are separated by a vertical ruled line. Lead finish/Ball material values may wrap to two lines if the finish value exceeds the maximum column width.

Important Information and Disclaimer: The information provided on this page represents TI's knowledge and belief as of the date that it is provided. TI bases its knowledge and belief on information provided by third parties, and makes no representation or warranty as to the accuracy of such information. Efforts are underway to better integrate information from third parties. TI has taken and continues to take reasonable steps to provide representative and accurate information but may not have conducted destructive testing or chemical analysis on incoming materials and chemicals. TI and TI suppliers consider certain information to be proprietary, and thus CAS numbers and other limited information may not be available for release.

In no event shall TI's liability arising out of such information exceed the total purchase price of the TI part(s) at issue in this document sold by TI to Customer on an annual basis.

OTHER QUALIFIED VERSIONS OF SN54HC32, SN54HC32-SP, SN74HC32 :

● Catalog: [SN74HC32](#), [SN54HC32](#)

● Military: [SN54HC32](#)

● Space: [SN54HC32-SP](#)

NOTE: Qualified Version Definitions:

- Catalog - TI's standard catalog product
- Military - QML certified for Military and Defense Applications
- Space - Radiation tolerant, ceramic packaging and qualified for use in Space-based application

TAPE AND REEL INFORMATION

QUADRANT ASSIGNMENTS FOR PIN 1 ORIENTATION IN TAPE

*All dimensions are nominal

Device	Package Type	Package Drawing	Pins	SPQ	Reel Diameter (mm)	Reel Width W1 (mm)	A0 (mm)	B0 (mm)	K0 (mm)	P1 (mm)	W (mm)	Pin1 Quadrant
SN74HC32DR	SOIC	D	14	2500	330.0	16.4	6.5	9.0	2.1	8.0	16.0	Q1
SN74HC32DR	SOIC	D	14	2500	330.0	16.8	6.5	9.5	2.1	8.0	16.0	Q1
SN74HC32DR	SOIC	D	14	2500	330.0	16.4	6.5	9.0	2.1	8.0	16.0	Q1
SN74HC32DRG4	SOIC	D	14	2500	330.0	16.4	6.5	9.0	2.1	8.0	16.0	Q1
SN74HC32DRG4	SOIC	D	14	2500	330.0	16.4	6.5	9.0	2.1	8.0	16.0	Q1
SN74HC32DT	SOIC	D	14	250	330.0	16.4	6.5	9.0	2.1	8.0	16.0	Q1
SN74HC32PWR	TSSOP	PW	14	2000	330.0	12.4	6.9	5.6	1.6	8.0	12.0	Q1
SN74HC32PWR	TSSOP	PW	14	2000	330.0	12.4	6.9	5.6	1.6	8.0	12.0	Q1
SN74HC32PWRG4	TSSOP	PW	14	2000	330.0	12.4	6.9	5.6	1.6	8.0	12.0	Q1
SN74HC32PWT	TSSOP	PW	14	250	330.0	12.4	6.9	5.6	1.6	8.0	12.0	Q1

TAPE AND REEL BOX DIMENSIONS

*All dimensions are nominal

Device	Package Type	Package Drawing	Pins	SPQ	Length (mm)	Width (mm)	Height (mm)
SN74HC32DR	SOIC	D	14	2500	333.2	345.9	28.6
SN74HC32DR	SOIC	D	14	2500	364.0	364.0	27.0
SN74HC32DR	SOIC	D	14	2500	367.0	367.0	38.0
SN74HC32DRG4	SOIC	D	14	2500	333.2	345.9	28.6
SN74HC32DRG4	SOIC	D	14	2500	367.0	367.0	38.0
SN74HC32DT	SOIC	D	14	250	210.0	185.0	35.0
SN74HC32PWR	TSSOP	PW	14	2000	364.0	364.0	27.0
SN74HC32PWR	TSSOP	PW	14	2000	367.0	367.0	35.0
SN74HC32PWRG4	TSSOP	PW	14	2000	367.0	367.0	35.0
SN74HC32PWT	TSSOP	PW	14	250	367.0	367.0	35.0

FK (S-CQCC-N**)

LEADLESS CERAMIC CHIP CARRIER

28 TERMINAL SHOWN



NO. OF TERMINALS **	A		B	
	MIN	MAX	MIN	MAX
20	0.342 (8,69)	0.358 (9,09)	0.307 (7,80)	0.358 (9,09)
28	0.442 (11,23)	0.458 (11,63)	0.406 (10,31)	0.458 (11,63)
44	0.640 (16,26)	0.660 (16,76)	0.495 (12,58)	0.560 (14,22)
52	0.740 (18,78)	0.761 (19,32)	0.495 (12,58)	0.560 (14,22)
68	0.938 (23,83)	0.962 (24,43)	0.850 (21,6)	0.858 (21,8)
84	1.141 (28,99)	1.165 (29,59)	1.047 (26,6)	1.063 (27,0)



4040140/D 01/11

- NOTES:
- All linear dimensions are in inches (millimeters).
 - This drawing is subject to change without notice.
 - This package can be hermetically sealed with a metal lid.
 - Falls within JEDEC MS-004

MECHANICAL DATA

NS (R-PDSO-G**)

PLASTIC SMALL-OUTLINE PACKAGE

14-PINS SHOWN



- NOTES:
- A. All linear dimensions are in millimeters.
 - B. This drawing is subject to change without notice.
 - C. Body dimensions do not include mold flash or protrusion, not to exceed 0,15.

W (R-GDFP-F14)

CERAMIC DUAL FLATPACK



- NOTES:
- A. All linear dimensions are in inches (millimeters).
 - B. This drawing is subject to change without notice.
 - C. This package can be hermetically sealed with a ceramic lid using glass frit.
 - D. Index point is provided on cap for terminal identification only.
 - E. Falls within MIL STD 1835 GDFP1-F14

J 14

GENERIC PACKAGE VIEW
CDIP - 5.08 mm max height
CERAMIC DUAL IN LINE PACKAGE



Images above are just a representation of the package family, actual package may vary.
Refer to the product data sheet for package details.

4040083-5/G

J0014A



PACKAGE OUTLINE

CDIP - 5.08 mm max height

CERAMIC DUAL IN LINE PACKAGE



4214771/A 05/2017

NOTES:

1. All controlling linear dimensions are in inches. Dimensions in brackets are in millimeters. Any dimension in brackets or parenthesis are for reference only. Dimensioning and tolerancing per ASME Y14.5M.
2. This drawing is subject to change without notice.
3. This package is hermetically sealed with a ceramic lid using glass frit.
4. Index point is provided on cap for terminal identification only and on press ceramic glass frit seal only.
5. Falls within MIL-STD-1835 and GDIP1-T14.

EXAMPLE BOARD LAYOUT

J0014A

CDIP - 5.08 mm max height

CERAMIC DUAL IN LINE PACKAGE



LAND PATTERN EXAMPLE
NON-SOLDER MASK DEFINED
SCALE: 5X



4214771/A 05/2017

D (R-PDSO-G14)

PLASTIC SMALL OUTLINE



- NOTES:
- A. All linear dimensions are in inches (millimeters).
 - B. This drawing is subject to change without notice.
 - $\triangle C$ Body length does not include mold flash, protrusions, or gate burrs. Mold flash, protrusions, or gate burrs shall not exceed 0.006 (0,15) each side.
 - $\triangle D$ Body width does not include interlead flash. Interlead flash shall not exceed 0.017 (0,43) each side.
 - E. Reference JEDEC MS-012 variation AB.

D (R-PDSO-G14)

PLASTIC SMALL OUTLINE



- NOTES:
- A. All linear dimensions are in millimeters.
 - B. This drawing is subject to change without notice.
 - C. Publication IPC-7351 is recommended for alternate designs.
 - D. Laser cutting apertures with trapezoidal walls and also rounding corners will offer better paste release. Customers should contact their board assembly site for stencil design recommendations. Refer to IPC-7525 for other stencil recommendations.
 - E. Customers should contact their board fabrication site for solder mask tolerances between and around signal pads.

PW (R-PDSO-G14)

PLASTIC SMALL OUTLINE



4040064-3/G 02/11

- NOTES:
- A. All linear dimensions are in millimeters. Dimensioning and tolerancing per ASME Y14.5M-1994.
 - B. This drawing is subject to change without notice.
 - C. Body length does not include mold flash, protrusions, or gate burrs. Mold flash, protrusions, or gate burrs shall not exceed 0,15 each side.
 - D. Body width does not include interlead flash. Interlead flash shall not exceed 0,25 each side.
 - E. Falls within JEDEC MO-153

PW (R-PDSO-G14)

PLASTIC SMALL OUTLINE



- NOTES:
- All linear dimensions are in millimeters.
 - This drawing is subject to change without notice.
 - Publication IPC-7351 is recommended for alternate designs.
 - Laser cutting apertures with trapezoidal walls and also rounding corners will offer better paste release. Customers should contact their board assembly site for stencil design recommendations. Refer to IPC-7525 for other stencil recommendations.
 - Customers should contact their board fabrication site for solder mask tolerances between and around signal pads.

N (R-PDIP-T**)

PLASTIC DUAL-IN-LINE PACKAGE

16 PINS SHOWN



- NOTES:
- A. All linear dimensions are in inches (millimeters).
 - B. This drawing is subject to change without notice.
 - Falls within JEDEC MS-001, except 18 and 20 pin minimum body length (Dim A).
 - The 20 pin end lead shoulder width is a vendor option, either half or full width.

DB (R-PDSO-G**)

PLASTIC SMALL-OUTLINE

28 PINS SHOWN



- NOTES: A. All linear dimensions are in millimeters.
 B. This drawing is subject to change without notice.
 C. Body dimensions do not include mold flash or protrusion not to exceed 0,15.
 D. Falls within JEDEC MO-150

IMPORTANT NOTICE AND DISCLAIMER

TI PROVIDES TECHNICAL AND RELIABILITY DATA (INCLUDING DATASHEETS), DESIGN RESOURCES (INCLUDING REFERENCE DESIGNS), APPLICATION OR OTHER DESIGN ADVICE, WEB TOOLS, SAFETY INFORMATION, AND OTHER RESOURCES "AS IS" AND WITH ALL FAULTS, AND DISCLAIMS ALL WARRANTIES, EXPRESS AND IMPLIED, INCLUDING WITHOUT LIMITATION ANY IMPLIED WARRANTIES OF MERCHANTABILITY, FITNESS FOR A PARTICULAR PURPOSE OR NON-INFRINGEMENT OF THIRD PARTY INTELLECTUAL PROPERTY RIGHTS.

These resources are intended for skilled developers designing with TI products. You are solely responsible for (1) selecting the appropriate TI products for your application, (2) designing, validating and testing your application, and (3) ensuring your application meets applicable standards, and any other safety, security, or other requirements. These resources are subject to change without notice. TI grants you permission to use these resources only for development of an application that uses the TI products described in the resource. Other reproduction and display of these resources is prohibited. No license is granted to any other TI intellectual property right or to any third party intellectual property right. TI disclaims responsibility for, and you will fully indemnify TI and its representatives against, any claims, damages, costs, losses, and liabilities arising out of your use of these resources.

TI's products are provided subject to TI's Terms of Sale (www.ti.com/legal/termsofsale.html) or other applicable terms available either on ti.com or provided in conjunction with such TI products. TI's provision of these resources does not expand or otherwise alter TI's applicable warranties or warranty disclaimers for TI products.

Mailing Address: Texas Instruments, Post Office Box 655303, Dallas, Texas 75265
Copyright © 2020, Texas Instruments Incorporated