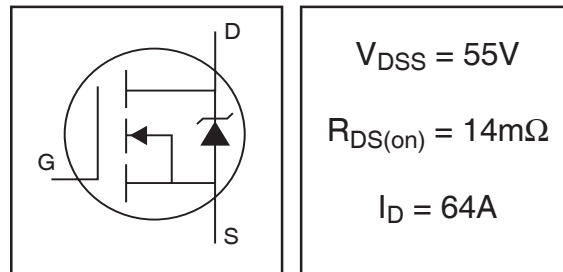


# IRFZ48NPbF

HEXFET<sup>®</sup> Power MOSFET

- Advanced Process Technology
- Ultra Low On-Resistance
- Dynamic dv/dt Rating
- 175°C Operating Temperature
- Fast Switching
- Fully Avalanche Rated
- Lead-Free



## Description

Advanced HEXFET<sup>®</sup> Power MOSFETs from International Rectifier utilize advanced processing techniques to achieve extremely low on-resistance per silicon area. This benefit, combined with the fast switching speed and ruggedized device design that HEXFET power MOSFETs are well known for, provides the designer with an extremely efficient and reliable device for use in a wide variety of applications.

The TO-220 package is universally preferred for all commercial-industrial applications at power dissipation levels to approximately 50 watts. The low thermal resistance and low package cost of the TO-220 contribute to its wide acceptance throughout the industry.



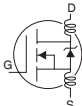
## Absolute Maximum Ratings

	Parameter	Max.	Units
$I_D @ T_C = 25^\circ C$	Continuous Drain Current, $V_{GS} @ 10V$	64	A
$I_D @ T_C = 100^\circ C$	Continuous Drain Current, $V_{GS} @ 10V$	45	
$I_{DM}$	Pulsed Drain Current ①	210	
$P_D @ T_C = 25^\circ C$	Power Dissipation	130	W
	Linear Derating Factor	0.83	W/°C
$V_{GS}$	Gate-to-Source Voltage	$\pm 20$	V
$I_{AR}$	Avalanche Current ①	32	A
$E_{AR}$	Repetitive Avalanche Energy ①	13	mJ
dv/dt	Peak Diode Recovery dv/dt ③	5.0	V/ns
$T_J$	Operating Junction and Storage Temperature Range	-55 to + 175	°C
$T_{STG}$			
	Mounting torque, 6-32 or M3 screw	10 lbf•in (1.1N•m)	

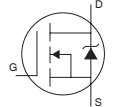
## Thermal Resistance

	Parameter	Typ.	Max.	Units
$R_{\theta JC}$	Junction-to-Case	—	1.15	°C/W
$R_{\theta CS}$	Case-to-Sink, Flat, Greased Surface	0.50	—	
$R_{\theta JA}$	Junction-to-Ambient	—	62	

## Electrical Characteristics @ $T_J = 25^\circ\text{C}$ (unless otherwise specified)

	Parameter	Min.	Typ.	Max.	Units	Conditions
$V_{(BR)DSS}$	Drain-to-Source Breakdown Voltage	55	—	—	V	$V_{GS} = 0V, I_D = 250\mu A$
$\Delta V_{(BR)DSS}/\Delta T_J$	Breakdown Voltage Temp. Coefficient	—	0.058	—	V/°C	Reference to $25^\circ\text{C}$ , $I_D = 1\text{mA}$
$R_{DS(on)}$	Static Drain-to-Source On-Resistance	—	—	14	mΩ	$V_{GS} = 10V, I_D = 32A$ ④
$V_{GS(th)}$	Gate Threshold Voltage	2.0	—	4.0	V	$V_{DS} = V_{GS}, I_D = 250\mu A$
$g_{fs}$	Forward Transconductance	24	—	—	S	$V_{DS} = 25V, I_D = 32A$ ④
$I_{DSS}$	Drain-to-Source Leakage Current	—	—	25	μA	$V_{DS} = 55V, V_{GS} = 0V$
		—	—	250		$V_{DS} = 44V, V_{GS} = 0V, T_J = 150^\circ\text{C}$
$I_{GSS}$	Gate-to-Source Forward Leakage	—	—	100	nA	$V_{GS} = 20V$
	Gate-to-Source Reverse Leakage	—	—	-100		$V_{GS} = -20V$
$Q_g$	Total Gate Charge	—	—	81	nC	$I_D = 32A$
$Q_{gs}$	Gate-to-Source Charge	—	—	19		$V_{DS} = 44V$
$Q_{gd}$	Gate-to-Drain ("Miller") Charge	—	—	30		$V_{GS} = 10V$ , See Fig. 6 and 13
$t_{d(on)}$	Turn-On Delay Time	—	12	—	ns	$V_{DD} = 28V$
$t_r$	Rise Time	—	78	—		$I_D = 32A$
$t_{d(off)}$	Turn-Off Delay Time	—	34	—		$R_G = 0.85\Omega$
$t_f$	Fall Time	—	50	—		$V_{GS} = 10V$ , See Fig. 10 ④
$L_D$	Internal Drain Inductance	—	4.5	—	nH	Between lead, 6mm (0.25in.) from package and center of die contact
$L_S$	Internal Source Inductance	—	7.5	—		
$C_{iss}$	Input Capacitance	—	1970	—	pF	$V_{GS} = 0V$
$C_{oss}$	Output Capacitance	—	470	—		$V_{DS} = 25V$
$C_{rss}$	Reverse Transfer Capacitance	—	120	—		$f = 1.0\text{MHz}$ , See Fig. 5
$E_{AS}$	Single Pulse Avalanche Energy ②	—	700 ⑤	190 ⑥		mJ

## Source-Drain Ratings and Characteristics

	Parameter	Min.	Typ.	Max.	Units	Conditions
$I_S$	Continuous Source Current (Body Diode)	—	—	64	A	MOSFET symbol showing the integral reverse p-n junction diode. 
$I_{SM}$	Pulsed Source Current (Body Diode) ①	—	—	210		
$V_{SD}$	Diode Forward Voltage	—	—	1.3	V	$T_J = 25^\circ\text{C}, I_S = 32A, V_{GS} = 0V$ ④
$t_{rr}$	Reverse Recovery Time	—	68	100	ns	$T_J = 25^\circ\text{C}, I_F = 32A$
$Q_{rr}$	Reverse Recovery Charge	—	220	330	nC	$di/dt = 100A/\mu s$ ④
$t_{on}$	Forward Turn-On Time	Intrinsic turn-on time is negligible (turn-on is dominated by $L_S+L_D$ )				

### Notes:

① Repetitive rating; pulse width limited by max. junction temperature. ( See fig. 11 )

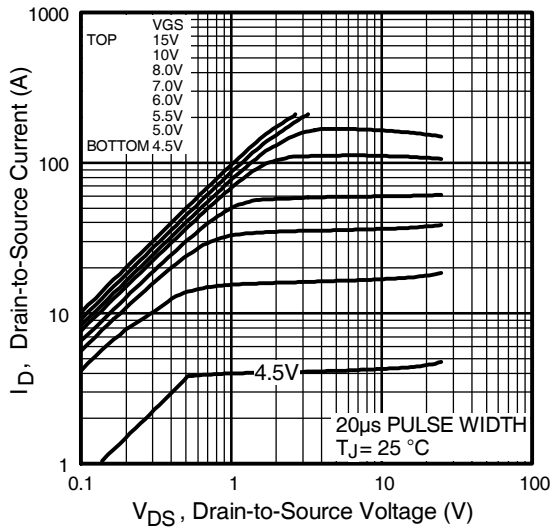
② Starting  $T_J = 25^\circ\text{C}$ ,  $L = 0.37\text{mH}$   
 $R_G = 25\Omega$ ,  $I_{AS} = 32A$ . (See Figure 12)

③  $I_{SD} \leq 32A$ ,  $di/dt \leq 220A/\mu s$ ,  $V_{DD} \leq V_{(BR)DSS}$ ,  
 $T_J \leq 175^\circ\text{C}$

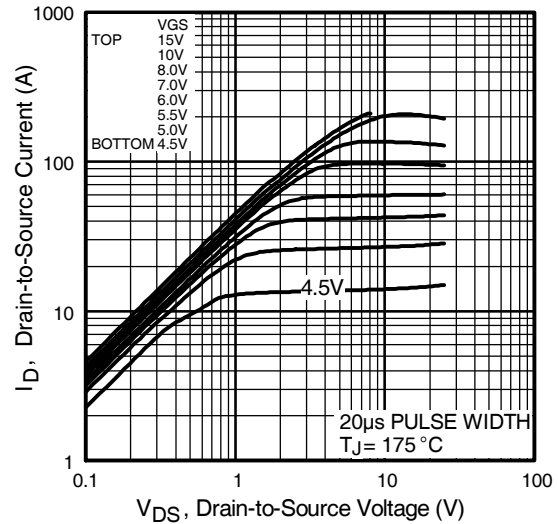
④ Pulse width  $\leq 400\mu s$ ; duty cycle  $\leq 2\%$ .

⑤ This is the destructive value not limited to the thermal limit.

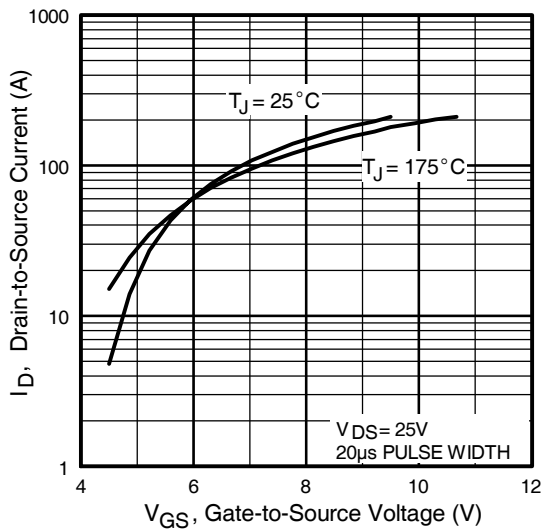
⑥ This is the thermal limited value.



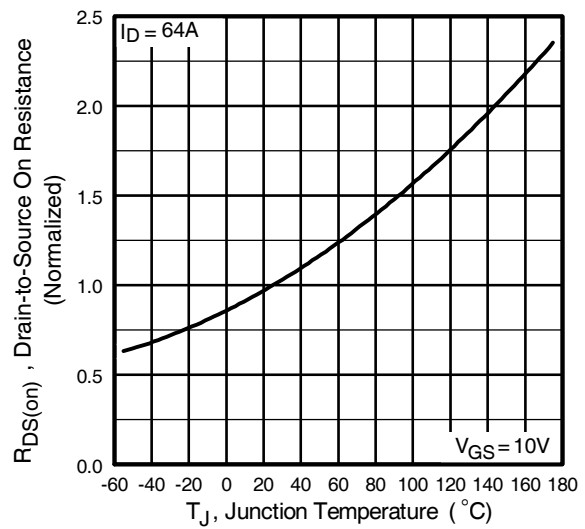
**Fig 1.** Typical Output Characteristics



**Fig 2.** Typical Output Characteristics



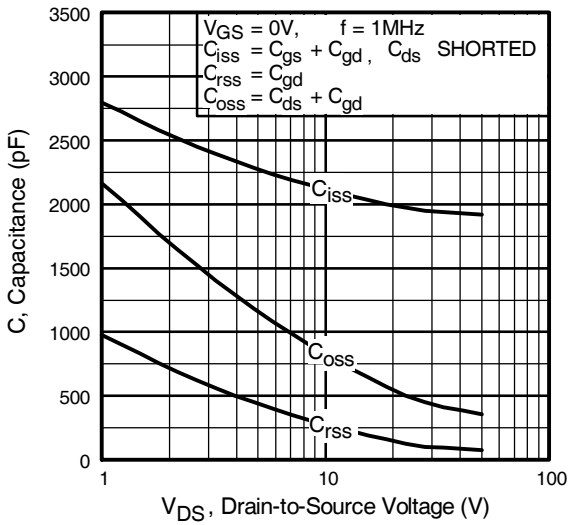
**Fig 3.** Typical Transfer Characteristics



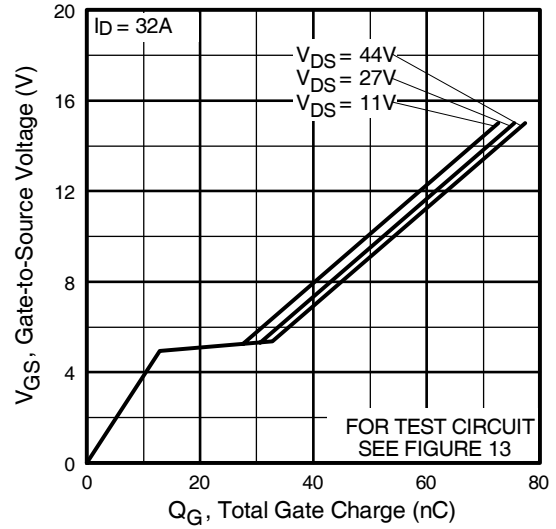
**Fig 4.** Normalized On-Resistance Vs. Temperature

# IRFZ48NPbF

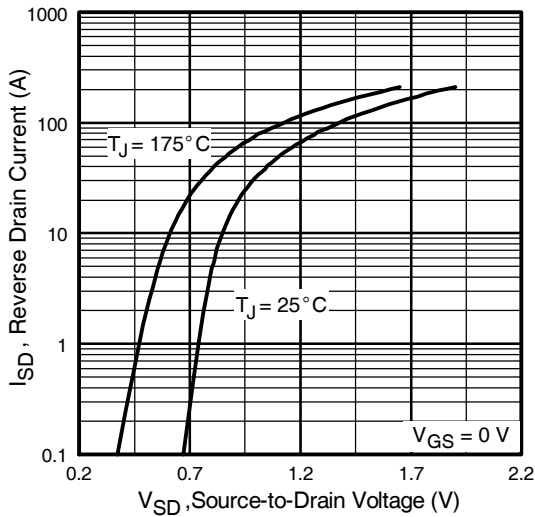
International  
**IR** Rectifier



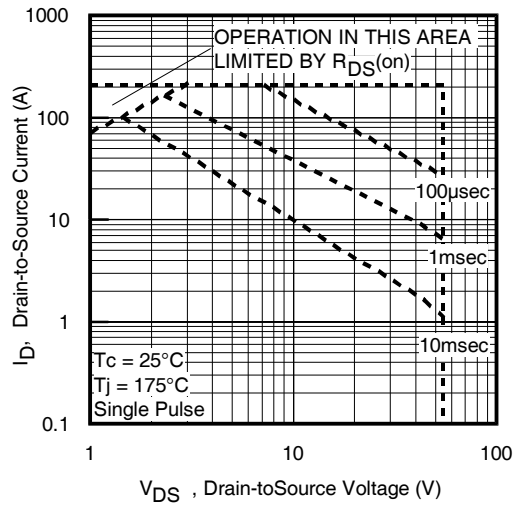
**Fig 5.** Typical Capacitance Vs. Drain-to-Source Voltage



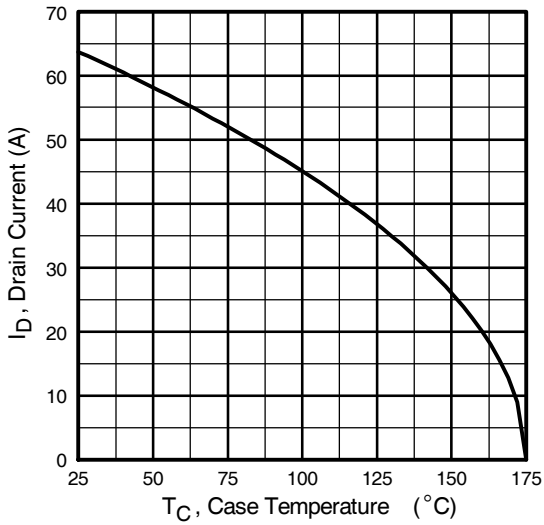
**Fig 6.** Typical Gate Charge Vs. Gate-to-Source Voltage



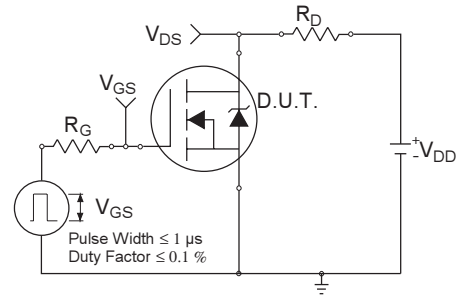
**Fig 7.** Typical Source-Drain Diode Forward Voltage



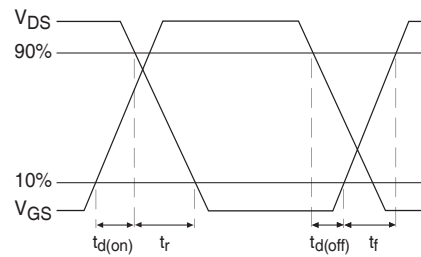
**Fig 8.** Maximum Safe Operating Area



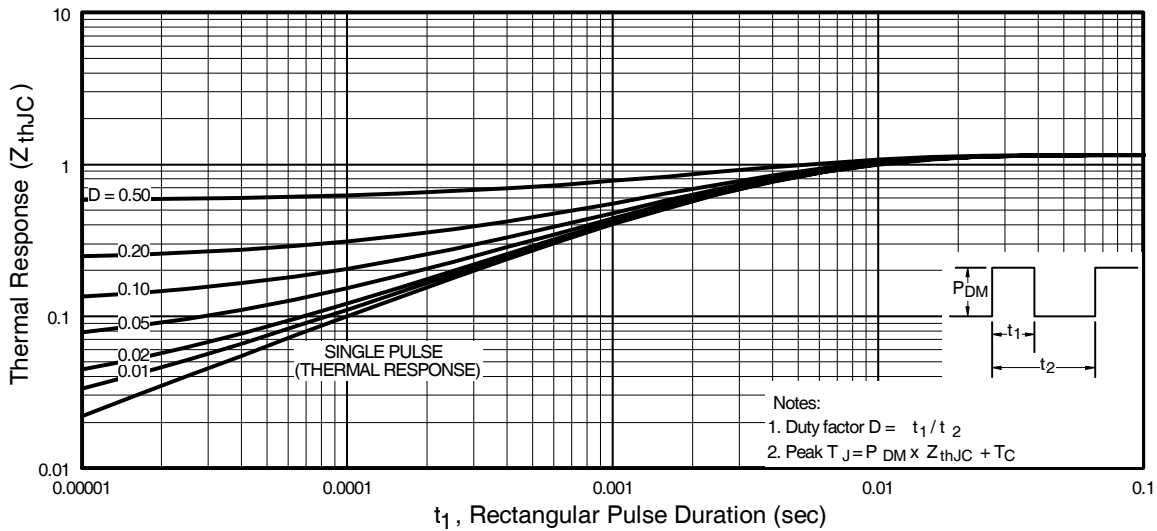
**Fig 9.** Maximum Drain Current Vs. Case Temperature



**Fig 10a.** Switching Time Test Circuit

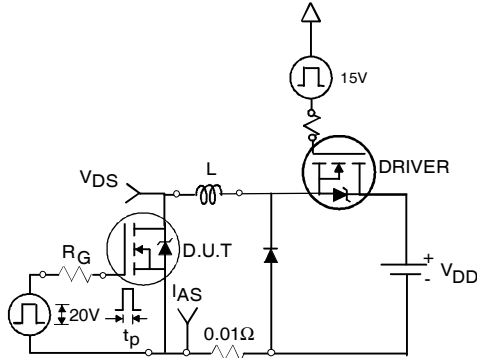


**Fig 10b.** Switching Time Waveforms

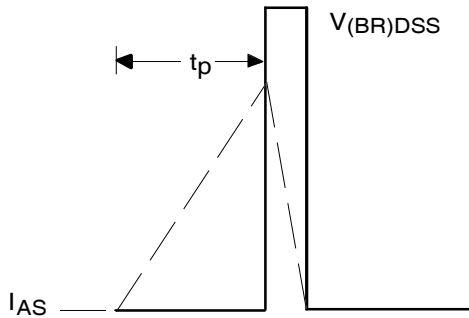


**Fig 11.** Maximum Effective Transient Thermal Impedance, Junction-to-Case

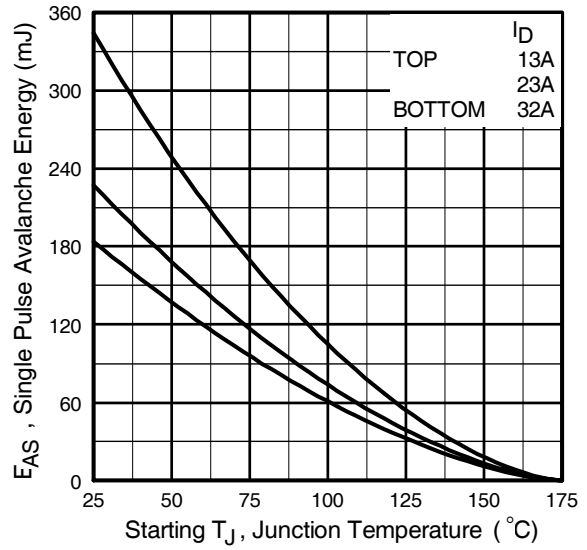
# IRFZ48NPbF



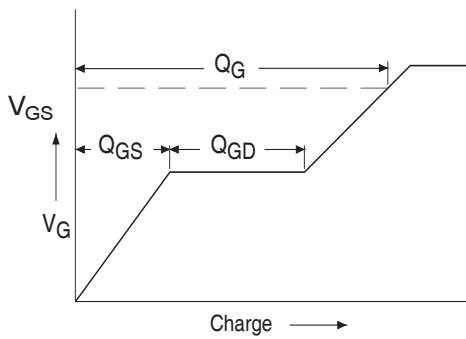
**Fig 12a.** Unclamped Inductive Test Circuit



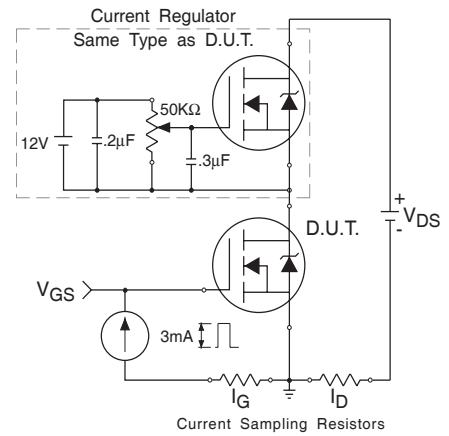
**Fig 12b.** Unclamped Inductive Waveforms



**Fig 12c.** Maximum Avalanche Energy Vs. Drain Current

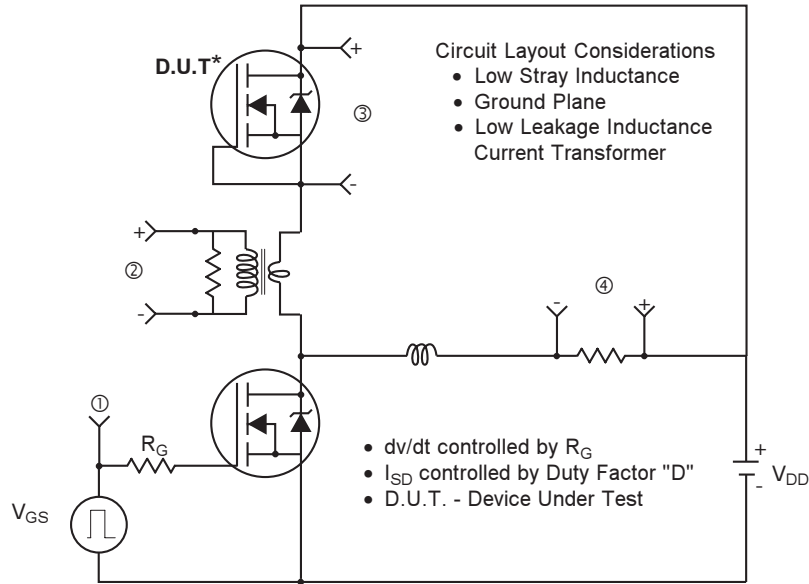


**Fig 13a.** Basic Gate Charge Waveform

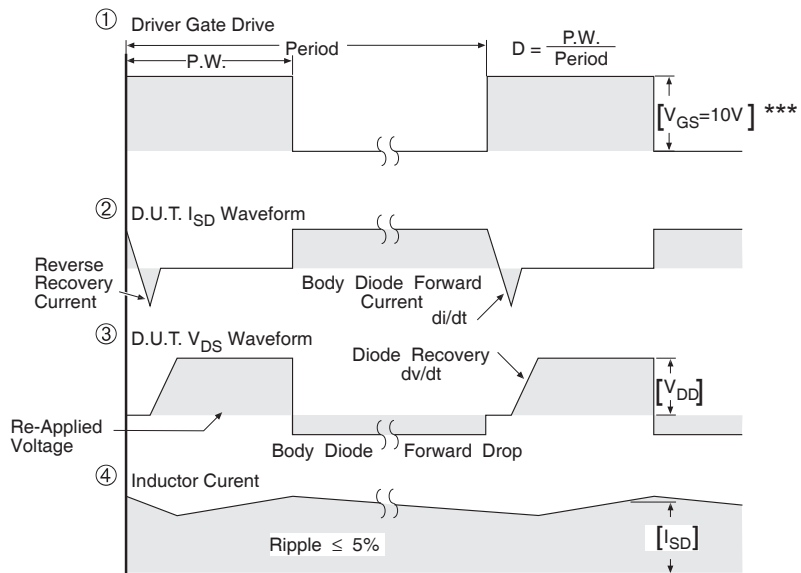


**Fig 13b.** Gate Charge Test Circuit

## Peak Diode Recovery dv/dt Test Circuit



\* Reverse Polarity of D.U.T for P-Channel



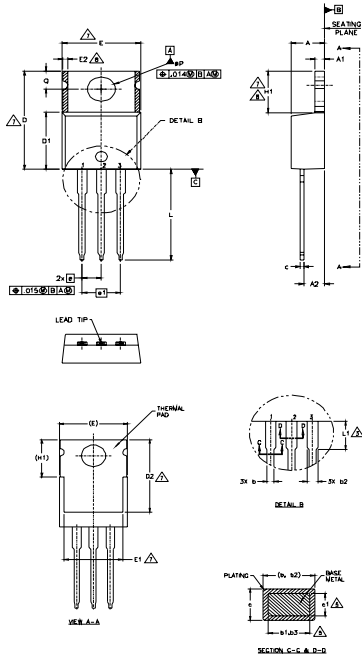
\*\*\*  $V_{GS} = 5.0V$  for Logic Level and 3V Drive Devices

**Fig 14.** For N-channel HEXFET® power MOSFETs

# IRFZ48NPbF

International  
**IR** Rectifier

## TO-220AB Package Outline (Dimensions are shown in millimeters (inches))



- NOTES:
- 1.- DIMENSIONING AND TOLERANCING AS PER ASME Y14.5 M- 1994.
  - 2.- DIMENSIONS ARE SHOWN IN INCHES [MILLIMETERS].
  - 3.- LEAD DIMENSION AND FINISH UNCONTROLLED IN L1.
  - 4.- DIMENSION D, D1 & E DO NOT INCLUDE MOLD FLASH. MOLD FLASH SHALL NOT EXCEED .005" (0.127) PER SIDE. THESE DIMENSIONS ARE MEASURED AT THE OUTERMOST EXTREMES OF THE PLASTIC BODY.
  - 5.- DIMENSION b1, b3 & c1 APPLY TO BASE METAL ONLY.
  - 6.- CONTROLLING DIMENSION : INCHES.
  - 7.- THERMAL PAD CONTOUR OPTIONAL WITHIN DIMENSIONS E,H1,D2 & E1
  - 8.- DIMENSION E2 X H1 DEFINE A ZONE WHERE STAMPING AND SINGULATION IRREGULARITIES ARE ALLOWED.
  - 9.- OUTLINE CONFORMS TO JEDEC TO-220, EXCEPT A2 (max) AND D2 (min.) WHERE DIMENSIONS ARE DERIVED FROM THE ACTUAL PACKAGE OUTLINE.

SYMBOL	DIMENSIONS				NOTES
	MILLIMETERS		INCHES		
	MIN.	MAX.	MIN.	MAX.	
A	3.56	4.83	.140	.190	
A1	0.51	1.40	.020	.055	
A2	2.03	2.92	.080	.115	
b	0.38	1.01	.015	.040	
b1	0.38	0.97	.015	.038	5
b2	1.14	1.78	.045	.070	
b3	1.14	1.73	.045	.068	5
c	0.36	0.61	.014	.024	
c1	0.36	0.56	.014	.022	5
D	14.22	16.51	.560	.650	4
D1	8.38	9.02	.330	.355	
D2	11.68	12.88	.460	.507	7
E	9.65	10.67	.380	.420	4,7
E1	6.86	8.89	.270	.350	7
E2	-	0.76	-	.030	8
e	2.54 BSC		.100 BSC		
e1	5.08 BSC		.200 BSC		
H1	5.84	6.86	.230	.270	7,8
L	12.70	14.73	.500	.580	
L1	-	6.35	-	.250	3
ØP	3.54	4.08	.139	.161	
Ø	2.54	3.42	.100	.135	

### LEAD ASSIGNMENTS

#### HEXFET

- 1- GATE
- 2- DRAIN
- 3- SOURCE

#### IGBTs, CoPACK

- 1- GATE
- 2- COLLECTOR
- 3- EMITTER

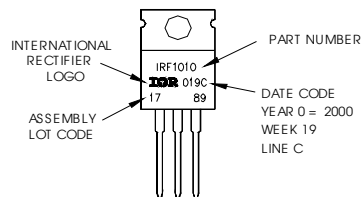
#### DIODES

- 1- ANODE/OPEN
- 2- CATHODE
- 3- ANODE

## TO-220AB Part Marking Information

EXAMPLE: THIS IS AN IRF1010  
LOT CODE 1789  
ASSEMBLED ON WW 19, 2000  
IN THE ASSEMBLY LINE "C"

Note: "P" in assembly line position  
indicates "Lead - Free"



### Notes:

1. For an Automotive Qualified version of this part please see <http://www.irf.com/product-info/auto/>
2. For the most current drawing please refer to IR website at <http://www.irf.com/package/>

Data and specifications subject to change without notice.  
This product has been designed and qualified for the Industrial market.  
Qualification Standards can be found on IR's Web site.

International  
**IR** Rectifier

IR WORLD HEADQUARTERS: 233 Kansas St., El Segundo, California 90245, USA Tel: (310) 252-7105  
TAC Fax: (310) 252-7903

Visit us at [www.irf.com](http://www.irf.com) for sales contact information.09/2010

[www.irf.com](http://www.irf.com)



## **IMPORTANT NOTICE**

The information given in this document shall in no event be regarded as a guarantee of conditions or characteristics ("Beschaffheitsgarantie").

With respect to any examples, hints or any typical values stated herein and/or any information regarding the application of the product, Infineon Technologies hereby disclaims any and all warranties and liabilities of any kind, including without limitation warranties of non-infringement of intellectual property rights of any third party.

In addition, any information given in this document is subject to customer's compliance with its obligations stated in this document and any applicable legal requirements, norms and standards concerning customer's products and any use of the product of Infineon Technologies in customer's applications.

The data contained in this document is exclusively intended for technically trained staff. It is the responsibility of customer's technical departments to evaluate the suitability of the product for the intended application and the completeness of the product information given in this document with respect to such application.

For further information on the product, technology, delivery terms and conditions and prices please contact your nearest Infineon Technologies office ([www.infineon.com](http://www.infineon.com)).

## **WARNINGS**

Due to technical requirements products may contain dangerous substances. For information on the types in question please contact your nearest Infineon Technologies office.

Except as otherwise explicitly approved by Infineon Technologies in a written document signed by authorized representatives of Infineon Technologies, Infineon Technologies' products may not be used in any applications where a failure of the product or any consequences of the use thereof can reasonably be expected to result in personal injury.