

Insulator: ABS UL94HB

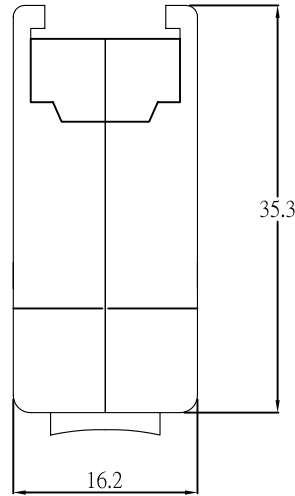

### Part Numbering System

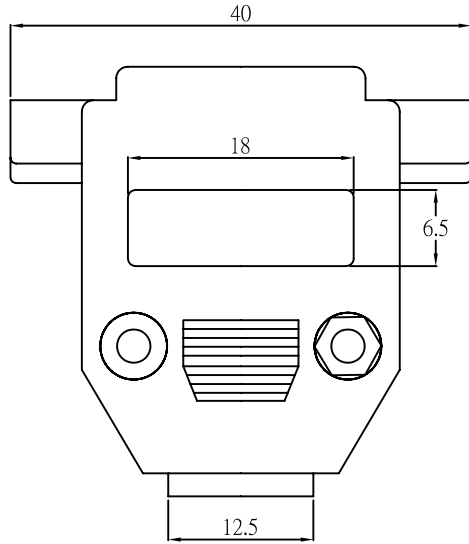
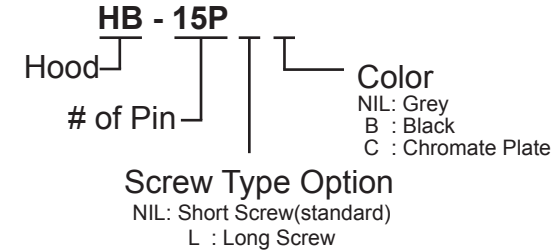

Packaging: 50 Individually sealed pieces per bag.

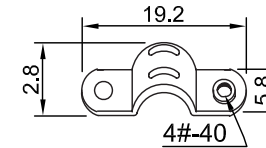

15P X 2/pcs

### Screw Type Option

#### Long Screw

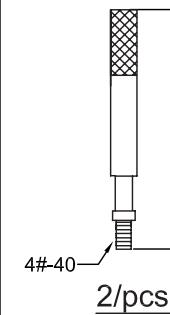

2/pcs

#### Short Screw

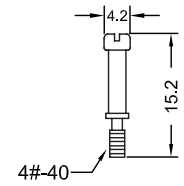

2/pcs

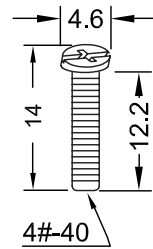
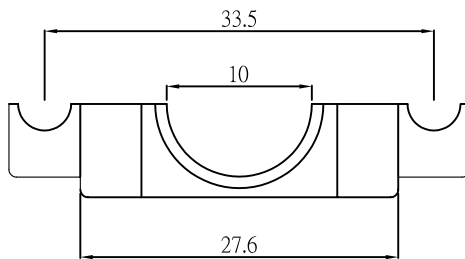

2/pcs

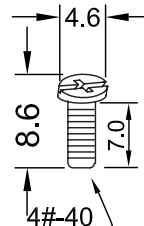

2/pcs

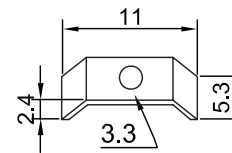

2/pcs

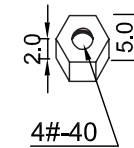

2/pcs

General Tolerance	
X. ± 0.50	X.° ± 5°
.X ± 0.20	.X° ± 2°
.XX ± 0.10	.XX° ± 1°
Units : mm	