

Ultra-small Surface-mounting Tactile Switches with High Contact Reliability (1.2 × 3 × 2.5 mm (H × W × D))

- Smallest class in the industry for high-density mounting of compact devices.
- Surface mounted: Ideal for high-density mounting.
- Models with ground terminals are available for protection against static electricity.
- Available on embossed tape: Ideal for automatic mounting.

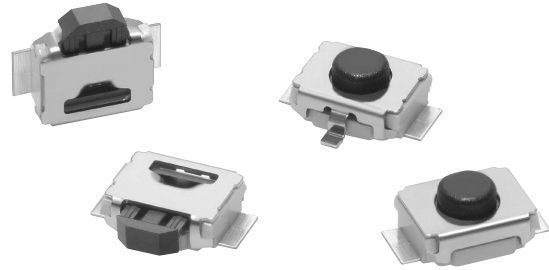

RoHS Compliant

List of Models

Operation type	Contact material	Height	Operating force (OF)	Plunger color	Locating pin	Embossed taping (standard quantity)			Embossed taping (small quantity)		
						Without ground terminal	With ground terminal	Minimum packing unit	Without ground terminal	With ground terminal	Minimum packing unit
B3U-1000 Series: Top-actuated	Silver plated	1.6 mm	1.5 N {153 gf}	Black	Without boss	B3U-1000P	B3U-1100P	3,500	B3U-1000PM	B3U-1100PM	1,000
					With boss	B3U-1000P-B	B3U-1100P-B		B3U-1000PM-B	B3U-1100PM-B	
B3U-3000 Series: Side-actuated		3.2 mm	1.59 N {162 gf}		Without boss	B3U-3000P	B3U-3100P	4,000	B3U-3000PM	B3U-3100PM	1,000
					With boss	B3U-3000P-B	B3U-3100P-B		B3U-3000PM-B	B3U-3100PM-B	

Note: Orders must be made in multiples of the order unit specified above.

Ratings/Characteristics

Item	Operation type	Top-actuated (B3U-1000 Series)	Side-actuated (B3U-3000 Series)
Rating (resistive load)		1 to 50 mA, 3 to 12 VDC	
Minimum applicable load (reference value)		10 μA at 1 VDC (resistive load)	
Ambient operating temperature		-25°C to +70°C at 60%RH max. (with no icing or condensation)	
Ambient operating humidity		35% to 85% (at +5 to +35°C)	
Contact form		SPST-NO	
Contact resistance (initial value)		100 mΩ max.	
Insulation resistance		100 MΩ min. (at 100 VDC with insulation tester)	
Dielectric strength		250 VAC, 50/60 Hz for 1 min	
Bounce time		5 ms max.	
Vibration resistance		10 to 55 Hz, 1.5 mm double amplitude	
Shock resistance		1,000 m/s ² max.	
Durability		200,000 operations min.	100,000 operations min.
Weight		Approx. 0.022 g	
Degree of protection		IEC IP40	
Washing		Not possible	

Operating Characteristics

Item	Operation type	Top-actuated (B3U-1000 Series)	Side-actuated (B3U-3000 Series)
Operating force (OF)		1.50 ± 0.49 N {153 ± 50 gf}	1.59 ± 0.49 N {162 ± 50 gf}
Releasing force (RF)		0.2 N min. {20 gf}	
Pretravel (PT)		0.15 ^{+0.2} _{-0.1} mm	0.2 ^{+0.2} _{-0.1} mm

■ Dimensions (Unit: mm)

Top-actuated Models

Without Ground Terminal, without Boss
B3U-1000P(M)

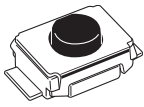

Terminal Arrangement /Internal Connections (Top View)

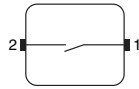

PCB Pad (Top View)

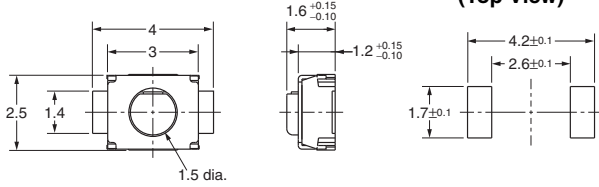

With Ground Terminal, without Boss
B3U-1100P(M)

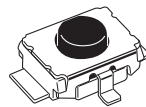

Terminal Arrangement /Internal Connections (Top View)

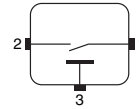

PCB Pad (Top View)

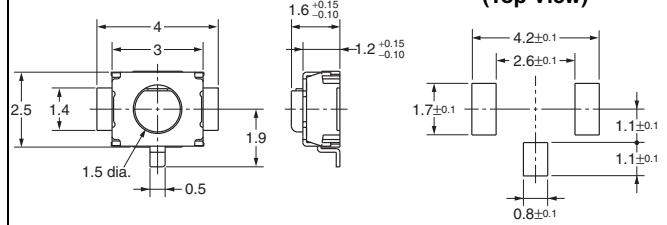

Without Ground Terminal, with Boss
B3U-1000P(M)-B

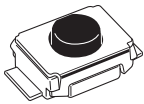

Terminal Arrangement /Internal Connections (Top View)

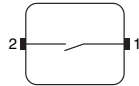

PCB Pad (Top View)

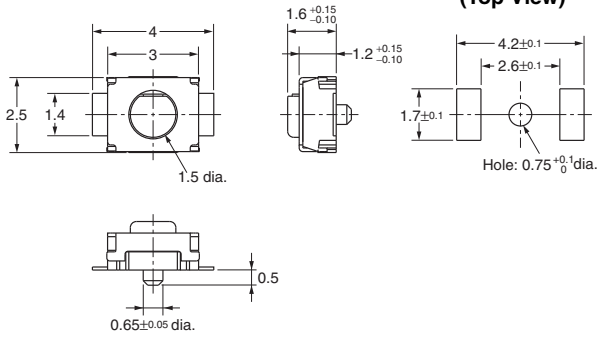

With Ground Terminal, with Boss
B3U-1100P(M)-B

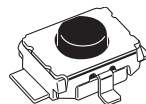

Terminal Arrangement /Internal Connections (Top View)

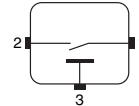

PCB Pad (Top View)

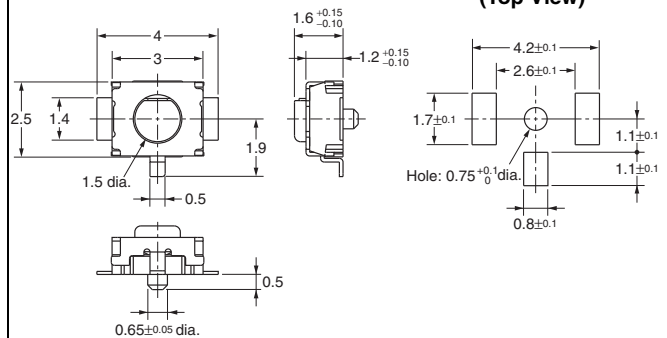

Note: Unless otherwise specified, a tolerance of ±0.2 mm applies to all dimensions. No terminal numbers are indicated on the Switches.

Side-actuated Models

Without Ground Terminal, without Boss

B3U-3000P(M)

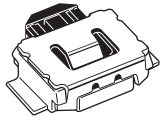

Terminal Arrangement / Internal Connections (Top View)

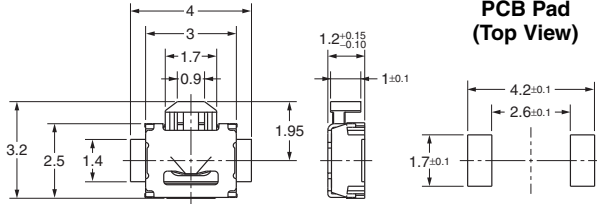
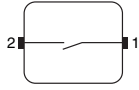

With Ground Terminal, without Boss

B3U-3100P(M)

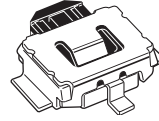

Terminal Arrangement / Internal Connections (Top View)

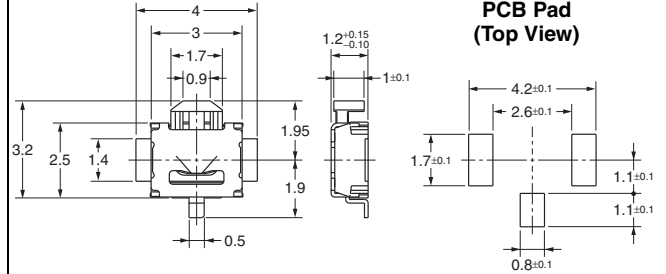
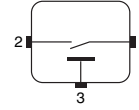

Without Ground Terminal, with Boss

B3U-3000P(M)-B

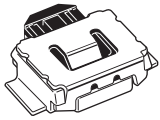

Terminal Arrangement / Internal Connections (Top View)

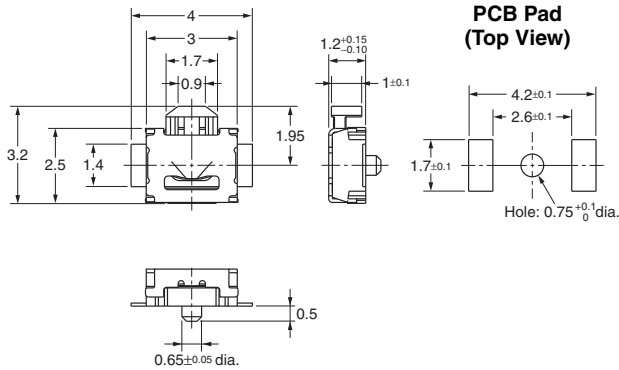

With Ground Terminal, with Boss

B3U-3100P(M)-B

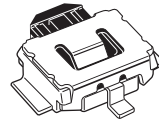

Terminal Arrangement / Internal Connections (Top View)

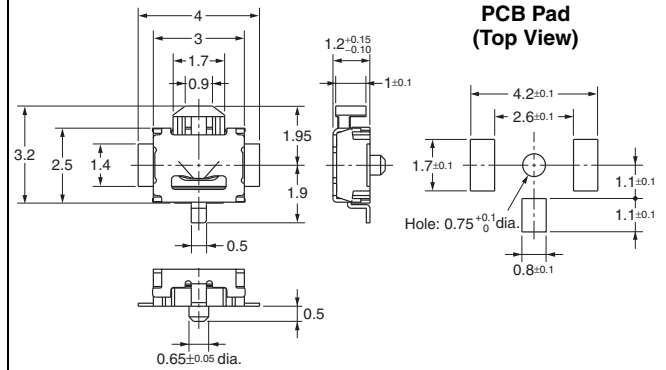
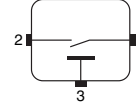

Note: Unless otherwise specified, a tolerance of ±0.2 mm applies to all dimensions. No terminal numbers are indicated on the Switches.

■ Precautions

Be sure to read the precautions common to all Tactile Switches on pages for correct use.