

Recommended
P.C. Board Hole Layout

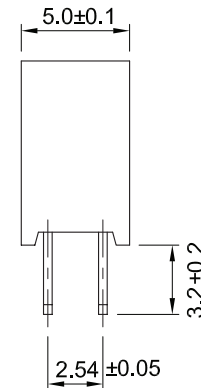
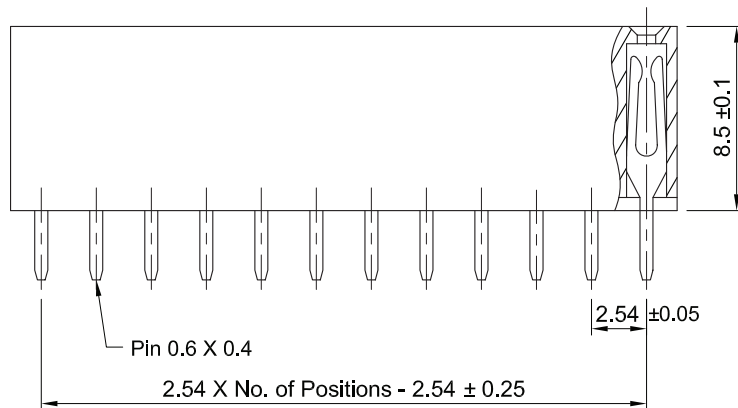
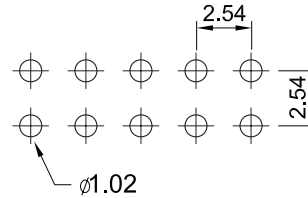

Specifications

- Current Rating: 3 Amps
- Insulator Resistance: 1000 Megohms min.
- Contact Resistance: 20 m ohms max.
- Dielectric Withstanding: AC 600V
- Operating Temperature : P.B.T.: -40°C ~ +105°C
Nylon-6T: -40°C ~ +125°C
- Contact Material: Phosphor Bronze
- Insulator Material: Polyester, UL 94V-0, P.B.T.
Polyester, UL 94V-0, Nylon-6T
- Contact Plated: See Option / Standard = Full Gold Flash

Part Numbering System

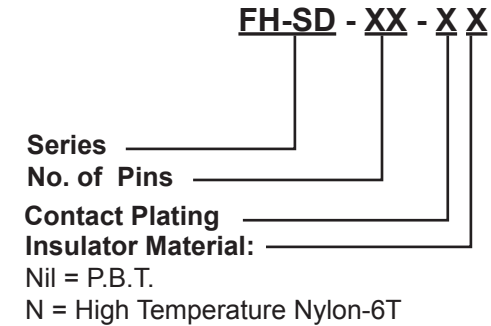

* Contact Plating Option	Full Gold Plating	Gold Plated On Contact Area Tin Plated on Solder Area	Full Tin Plating
	G : Gold Flash G10: Gold 10u" G15: Gold 15u" G30: Gold 30u"	S: Gold Flash S10: Gold 10u" S15: Gold 15u" S30: Gold 30u"	T: Tin 100u"

General Tolerance	
X. ± 0.50	X.° ± 5°
.X ± 0.20	.X° ± 2°
.XX ± 0.10	.XX° ± 1°
Units : mm	

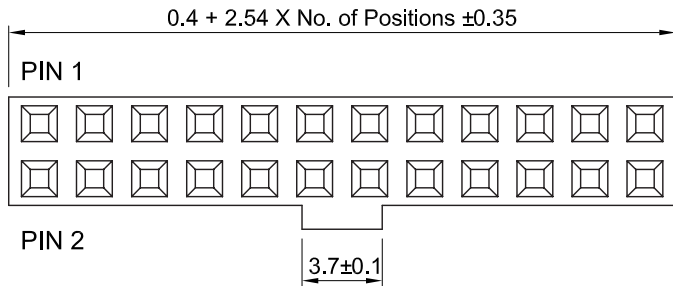

Recommended P.C. Board Hole Layout

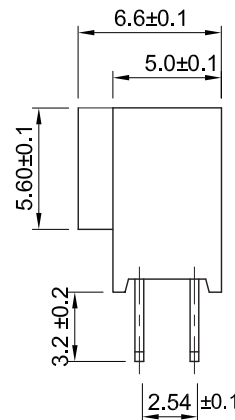
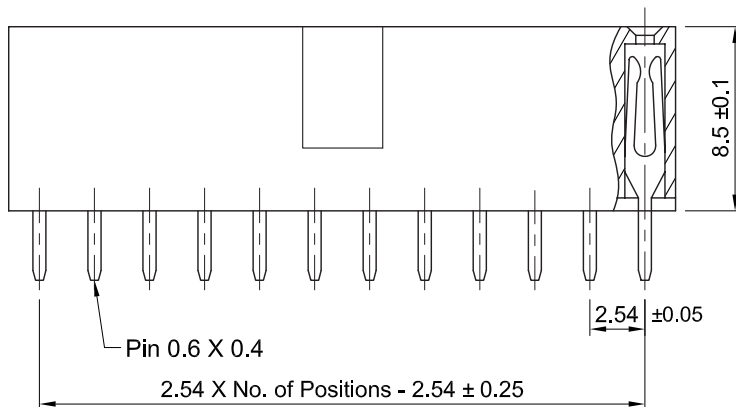
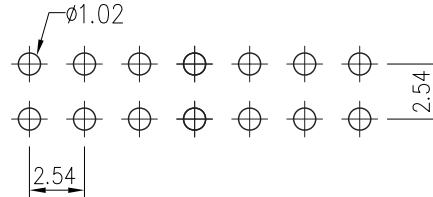

Specifications

- Current Rating: 3 Amps
- Insulator Resistance: 1000 Megohms min.
- Contact Resistance: 20 m ohms max.
- Dielectric Withstanding: AC 600V
- Operating Temperature : P.B.T.: -40°C ~ +105°C
- Nylon-6T: -40°C ~ +125°C
- Contact Material: Phosphor Bronze
- Insulator Material: Polyester, UL 94V-0, P.B.T.
Polyester, UL 94V-0, Nylon-6T
- Contact Plated: See Option / Standard = Full Gold Flash

Part Numbering System

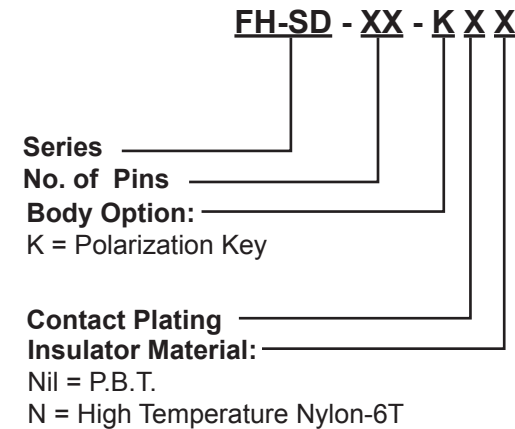

* Contact Plating Option	Full Gold Plating	Gold Plated On Contact Area Tin Plated on Solder Area	Full Tin Plating
	G : Gold Flash G10: Gold 10u" G15: Gold 15u" G30: Gold 30u"	S: Gold Flash S10: Gold 10u" S15: Gold 15u" S30: Gold 30u"	T: Tin 100u"

General Tolerance	
X. ± 0.50	X.° ± 5°
.X ± 0.20	.X° ± 2°
.XX ± 0.10	.XX° ± 1°
Units : mm	